

# Universal gripper UG

UG 20 & UG 25

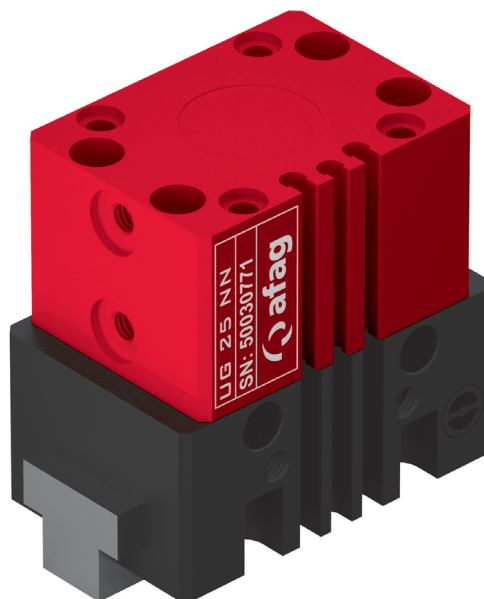
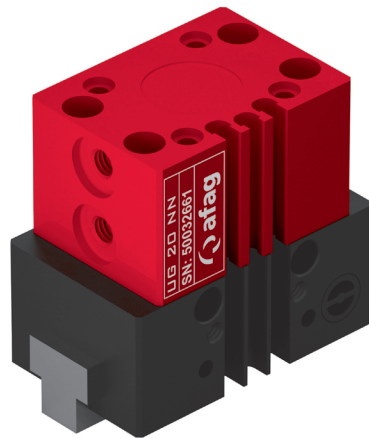

# Table of contents: UG

Universal gripper UG		Page
UG 20		124
UG 25		130



# Universal gripper UG

## UG 20

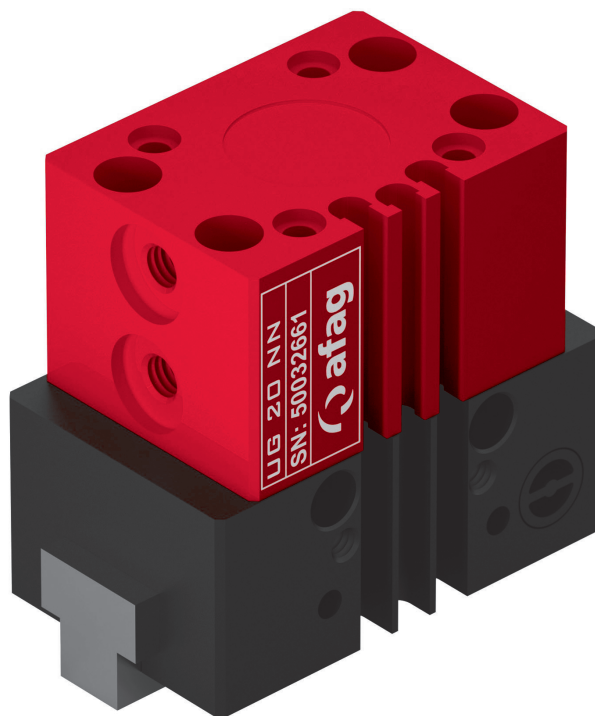

- Compact and light
- Third sensor for part recognition
- Gripping force securing

# Dimensions and dimension drawings

UG 20

Type	UG 20 NN	UG 20 NC	UG 20 NO
A	Sensor Ø 4 mm	Sensor Ø 4 mm	Sensor Ø 4 mm
B	Proximity switch	Proximity switch	Proximity switch

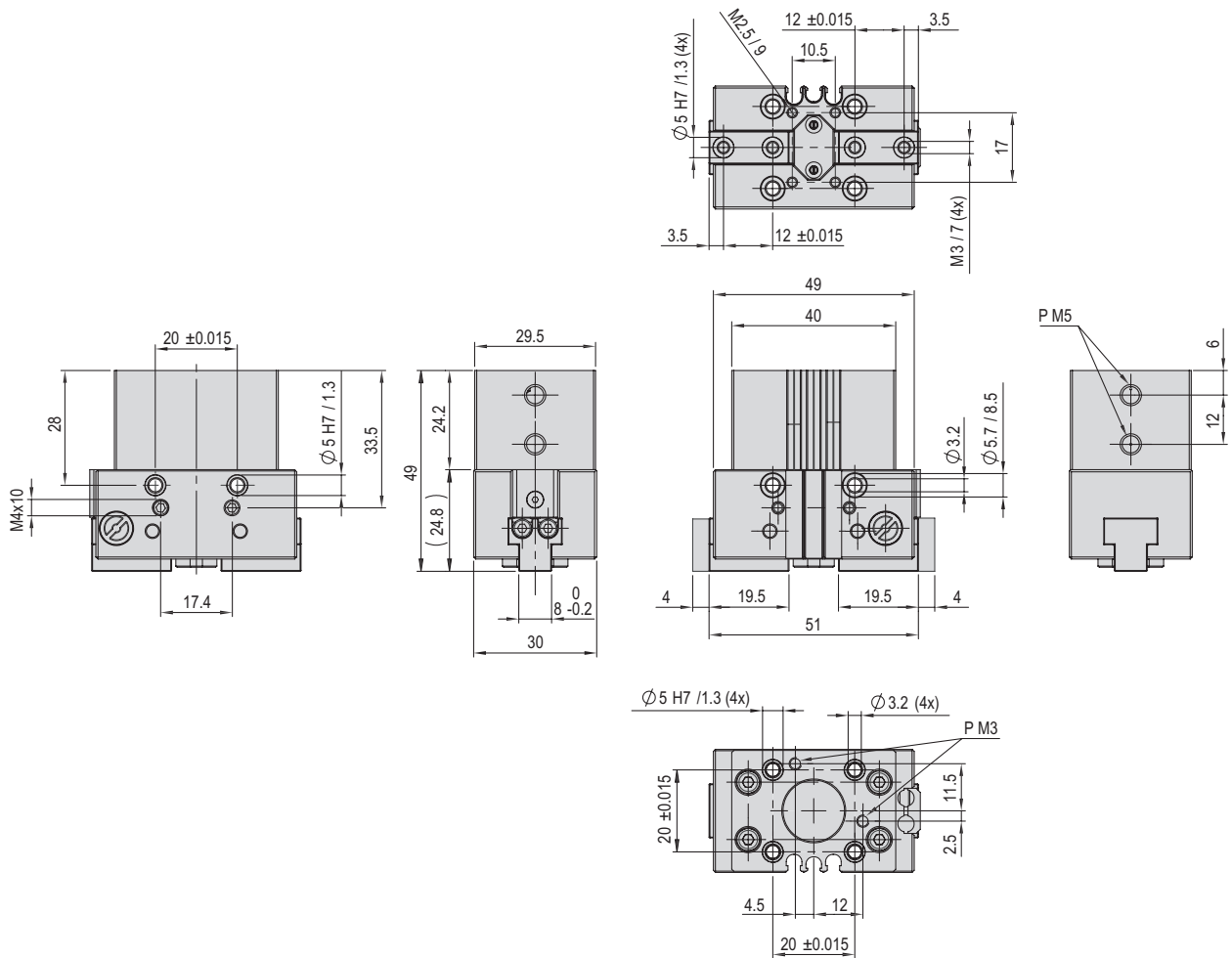

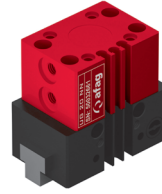

UG 20	
Attachment grid	20 x 20 mm
Attachment thread	Mounting holes 3.2 mm
Operating pressure	6 +/- 2 bar
Air connection P	M5
Cylinder Ø	20 mm
Operating temperature	0 - 50 °C

Type	UG 20 NN	UG 20 NC	UG 20 NO
<b>Order number</b>	<b>50032661</b>	<b>50032663</b>	<b>50032664</b>
Net weight	0.17 kg	0.172 kg	0.172 kg
Air consumption/cycle	0.0239 NL	0.0239 NL	0.0239 NL
Gripping time	0.03 s	0.03 s	0.03 s
Closing time	**Closing time = Finger weight 0.20 s = 150 g 0.05 s = 100 g 0.03 s = 80 g		
Gripping force, opening	178 N	139 N	226 N
Gripping force, closing	150 N	188 N	105 N
Max. admissible weight per gripper finger	150 g	150 g	150 g
Spring force		38 N	48 N
Opening stroke	2 x 4 mm	2 x 4 mm	2 x 4 mm
Repeat accuracy	+/- 0.02 mm	+/- 0.02 mm	+/- 0.02 mm
Mounting position	✦	✦	✦

The technical data refer to a nominal pressure of 6 bar under Afag standard test conditions.  
 The module can be operated with lubricated or dry air.  
 Cleanroom class ISO 14644-1, class ISO 7

- \*Observe gripping force diagrams
- Measurements for slowly closing fingers
- All module measurements carried out via outer clamping
- \*\*Closing times in unthrottled operation Observe gripping force diagrams
- Measurements for slowly closing fingers
- All module measurements carried out via outer clamping

### Included in the delivery

- (Catalogue HT accessories)
- 2x Centering bushing Ø5x2.5
  - 2x Mounting screw M3x30
  - 4x Mounting screw M3x50

### Accessories

- (Catalogue HT accessories)
- INI c10x19.5-Em-PNP-NO-M8x1
  - INI c10x28.5-Em-PNP-NO-M8x1

### Alternative accessories

- (Catalogue HT accessories)
- INI d4x25-Sn1.0-PNP-NC-M8x1
  - INI d4x25-Sn1.0-PNP-NO-M8x1
  - INI M4x12-Sn0.8-PNP-NO

Warranty: 24 months following commissioning, but a maximum of 27 months following delivery



CS 12	1,3	VP 107	1,2
CS 16	1,3	VP 107	1,2
LM 16	1	VP 115	1,2
LM 20	1	VP 115	1,2
LM 25	1	VP 115	1,2
LM 32	1	VP 115	1,2
PS 16	1 2,3	< direct > VP 107	1,2 1,2
PS 25	1 2,3	VP 107 VP 115	1,2 1,2
HM 10	1	VP 107	1,2
CR 12	3	< direct >	1,2
CR 16	3	< direct >	1,2
RM 16	3	VF 404	1,2
RM 25	3	VF 404	1,2
ES20	1,3	VP 107	1,2
ES30	1	< direct >	1,2
SA-1	1	< direct >	2
SA-3	1,2	VP 107	1,2
SA-6	1,2	VP 107	1,2
LE-50	1	VP 107	1,2
RE-50	3 3	< direct > VP 107	1 2

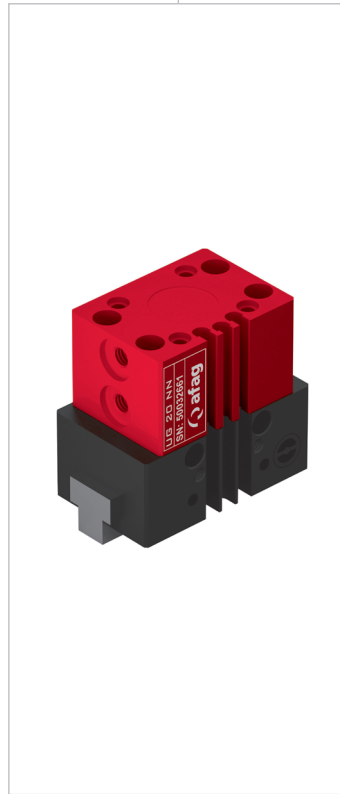

↑ ↑  
**Mounting areas**

CS, ES 	PS 	LM, LE 	HM 	SA 	OZ 
PMP, PMP-c 	PEZ, PDZ 	PEL, PDL 	CR, RM 32, RE 	RM, RE 	UG, GM, GE, SG, DG, PG, GM RE 

Note that there might be different mounting positions from one module to another one.

The required connection elements and the range of support columns are depicted in the catalogue HT accessories.

Type	UG 20 NN
Max. static torque $M_x$	7 Nm
Max. static torque $M_y$	7 Nm
Max. static torque $M_z$	7 Nm
Max. dynamic torque $M_x$	0.07 Nm
Max. dynamic torque $M_y$	0.07 Nm
Max. dynamic torque $M_z$	0.07 Nm
Max. static force $F$	150 N
Max. dynamic force $F$	1.5 N

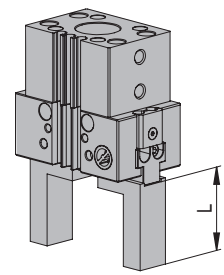
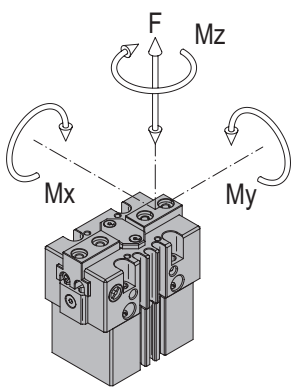

Finger length centric

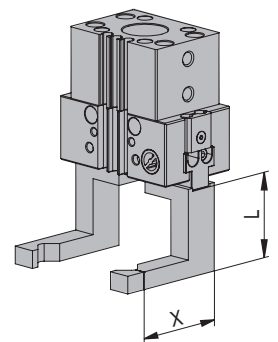

Finger length eccentric

### Gripping force diagrams per jaw

Eccentric - UG 20 NN opening

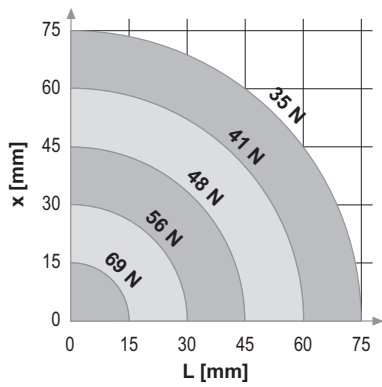

Eccentric - UG 20 NN closing

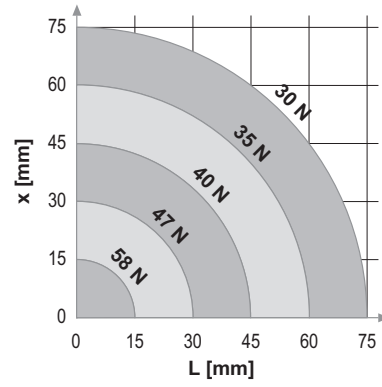

Centric - UG 20 NN opening

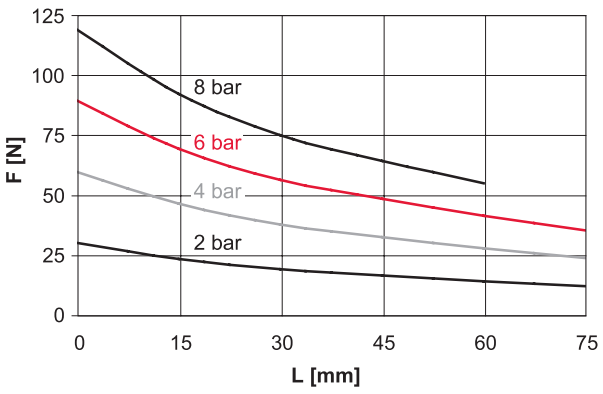

Centric - UG 20 NN closing

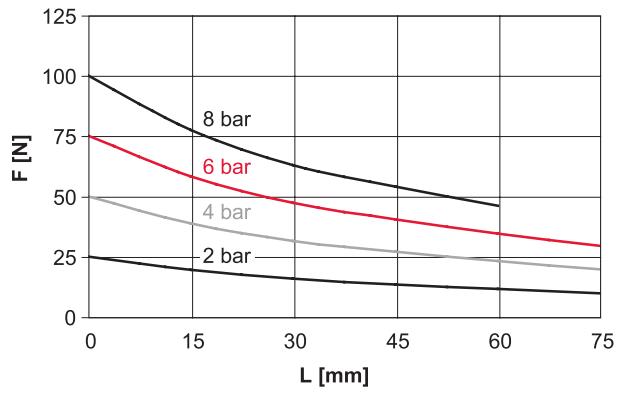



Eccentric - UG 20 NC closing

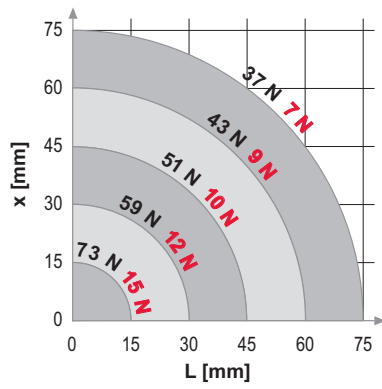

Centric - UG 20 NC closing

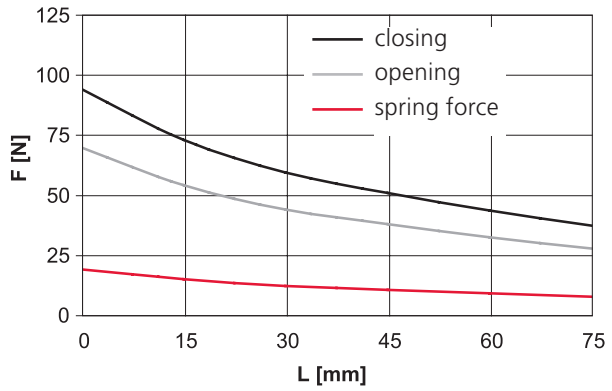

Eccentric - UG 20 NN opening

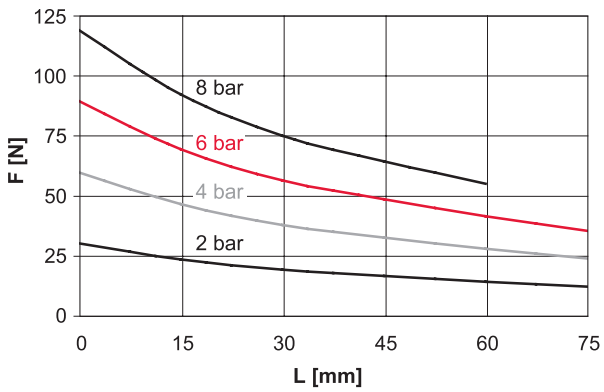

Centric - UG 20 NO opening

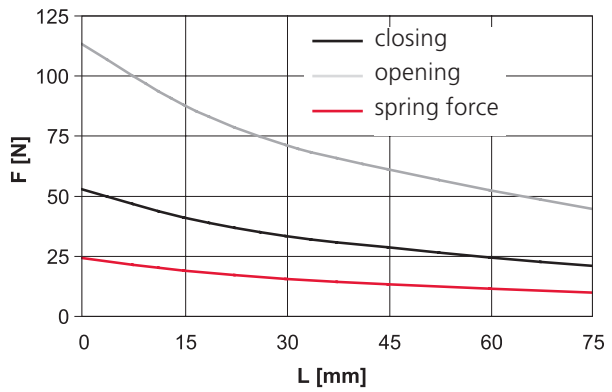

# Universal gripper UG

## UG 25

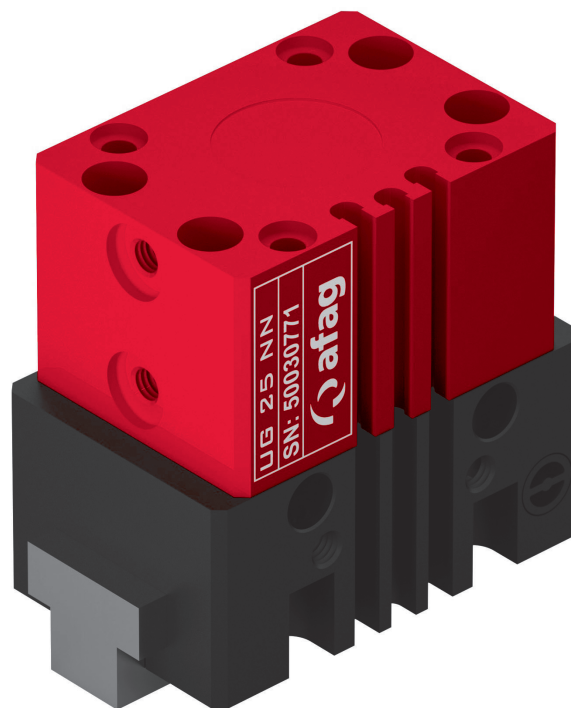

- Compact and light
- Third sensor for part recognition
- Gripping force securing

# Dimensions and dimension drawings

UG 25

Type	UG 25 NN	UG 25 NC	UG 25 NO
A	Sensor Ø 4 mm	Sensor Ø 4 mm	Sensor Ø 4 mm
B	Proximity switch	Proximity switch	Proximity switch

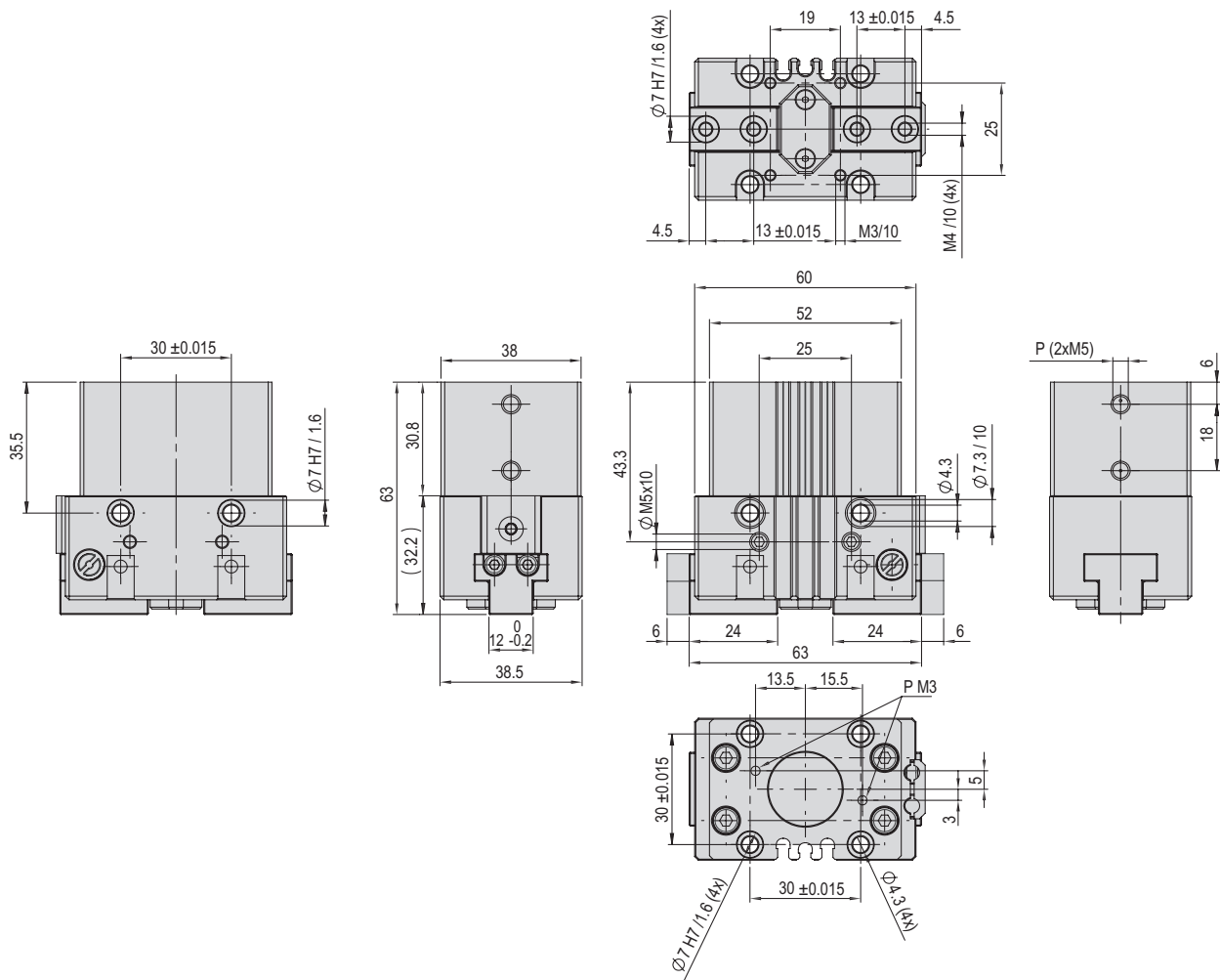

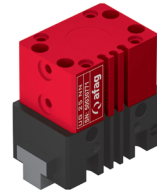

UG 25	
Attachment grid	30 x 30 mm
Attachment thread	Mounting holes 4.3 mm
Operating pressure	6 +/- 2 bar
Air connection P	M5
Cylinder Ø	25 mm
Operating temperature	0 - 50 °C

Type	UG 25 NN	UG 25 NC	UG 25 NO
<b>Order number</b>	<b>50030771</b>	<b>50030772</b>	<b>50030773</b>
Net weight	0.384 kg	0.389 kg	0.388 kg
Air consumption/cycle	0.0552 NL	0.0552 NL	0.0552 NL
Gripping time	0.05 s	0.05 s	0.05 s
Closing time	**Closing time = Finger weight 0.20 s = 250 g 0.05 s = 150 g 0.03 s = -		
Gripping force, opening	*334 N	*268 N	*407 N
Gripping force, closing	*300 N	*366 N	*227 N
Max. admissible weight per gripper finger	250 g	250 g	250 g
Spring force		66 N	73 N
Opening stroke	2 x 6 mm	2 x 6 mm	2 x 6 mm
Repeat accuracy	+/- 0.02 mm	+/- 0.02 mm	+/- 0.02 mm
Mounting position	✦	✦	✦

The technical data refer to a nominal pressure of 6 bar under Afag standard test conditions.  
The module can be operated with lubricated or dry air.  
Cleanroom class ISO 14644-1, class ISO 7

- \*Observe gripping force diagrams
- Measurements for slowly closing fingers
- All module measurements carried out via outer clamping
- \*\*Closing times in unthrottled operation Observe gripping force diagrams
- Measurements for slowly closing fingers
- All module measurements carried out via outer clamping.

### Included in the delivery

(Catalogue HT accessories)

- 2x Centering bushing Ø7x3
- 2x Mounting screw M4x35
- 4x Mounting screw M4x55

### Accessories

(Catalogue HT accessories)

- INI c10x19.5-Em-PNP-NO-M8x1
- INI c10x28.5-Em-PNP-NO-M8x1

Warranty: 24 months following commissioning, but a maximum of 27 months following delivery



CS 12	1	< direct >	1,2
CS 16	1,3	< direct >	1,2
CS 20	1,3	VP 115	1,2
LM 20	1	VP 115	1,2
LM 25	1	VP 115	1,2
LM 32	1	VP 115	1,2
PS 16	1,2,3	< direct >	1,2
PS 25	1 2,3	< direct > VP 115	1,2 1,2
PS 32	1 2,3	< direct > VP 112	1,2 1,2
HM 10	1	< direct >	1,2
HM 16	1	< direct >	1,2
CR 16	3	< direct >	1,2
CR 20	3	< direct >	1,2
RM 16	3	VF 404	1,2
RM 25	3	VF 404	1,2
RM 32	3	VF 405	1,2
ES20	1,3	< direct >	1,2
ES30	3 3	VP 115 VP 112	1 2
ES40	1	< direct >	1,2
ES40-HP	1	< direct >	1,2
SA-3	1,2	< direct >	1,2
SA-6	1,2	< direct >	1,2
OZ-50	1	< direct >	1,2
LE-50	1	< direct >	1,2
RE-50	3	< direct >	1,2

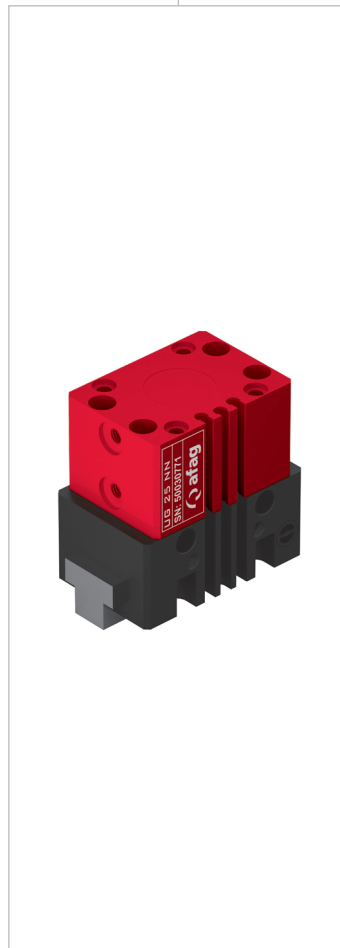

↑ ↑ **Mounting areas**

CS, ES 	PS 	LM, LE 	HM 	SA 	OZ 
PMP, PMP-c 	PEZ, PDZ 	PEL, PDL 	CR, RM 32, RE 	RM, RE 	UG, GM, GE, SG, DG, PG, GM RE 

Note that there might be different mounting positions from one module to another one.

The required connection elements and the range of support columns are depicted in the catalogue HT accessories.

Type	UG 25 NN
Max. static torque $M_x$	12 Nm
Max. static torque $M_y$	12 Nm
Max. static torque $M_z$	12 Nm
Max. dynamic torque $M_x$	0.12 Nm
Max. dynamic torque $M_y$	0.12 Nm
Max. dynamic torque $M_z$	0.12 Nm
Max. static force $F$	250 N
Max. dynamic force $F$	2.5 N

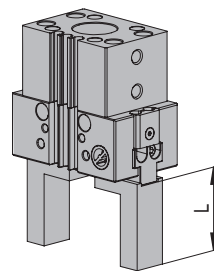
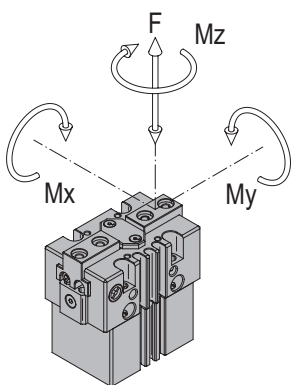

Finger length centric

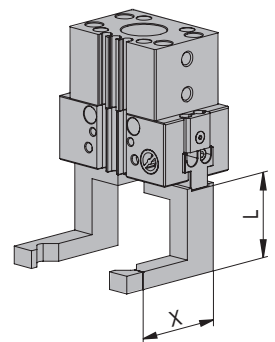

Finger length eccentric

### Gripping force diagrams per jaw

Eccentric - UG 25 NN opening

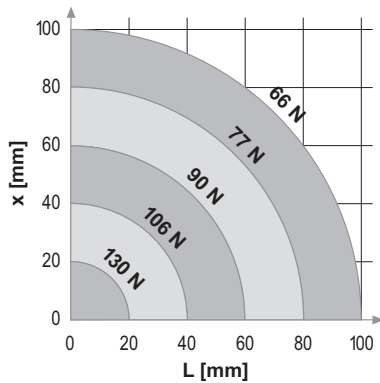

Eccentric - UG 25 NN closing

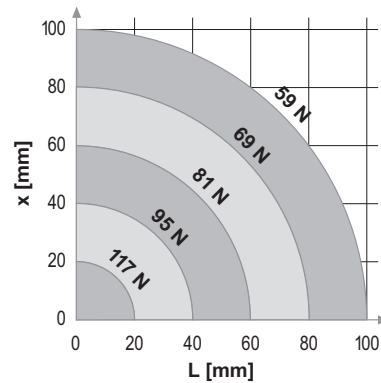

Centric - UG 25 NN opening

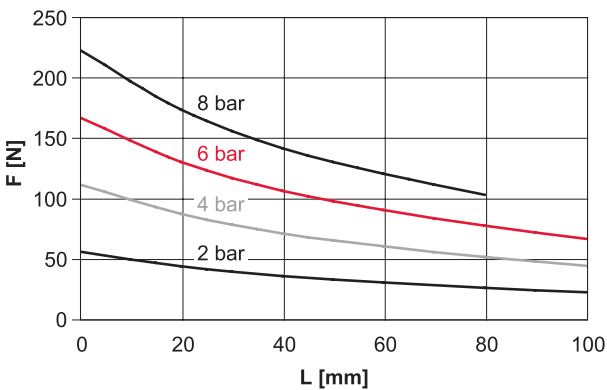

Centric - UG 25 NN closing

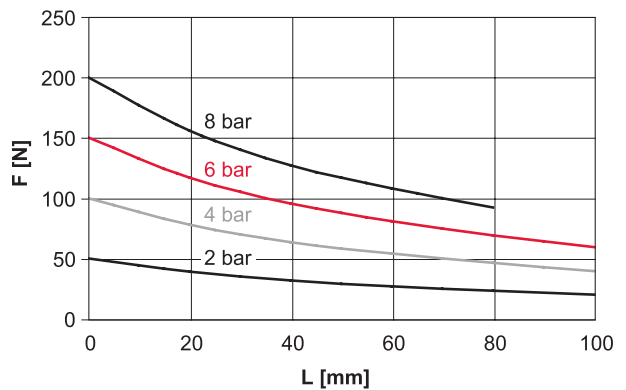

Eccentric - UG 25 NC opening

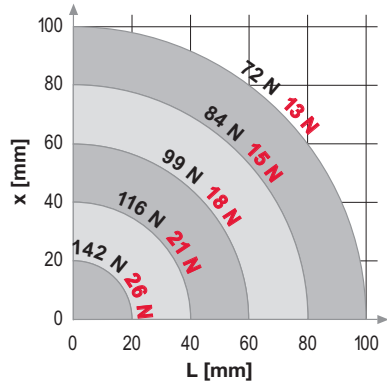

Centric - UG 25 NC closing

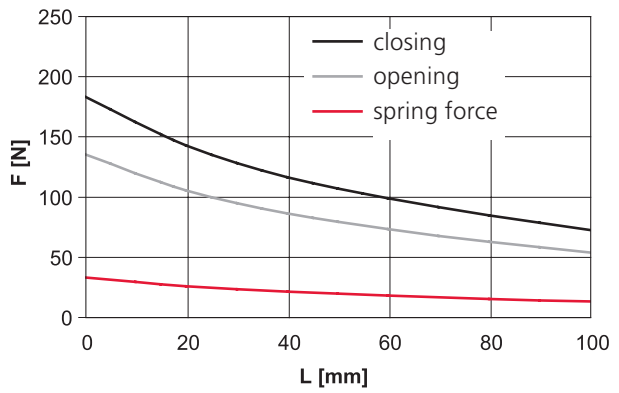

Eccentric - UG 25 NO opening

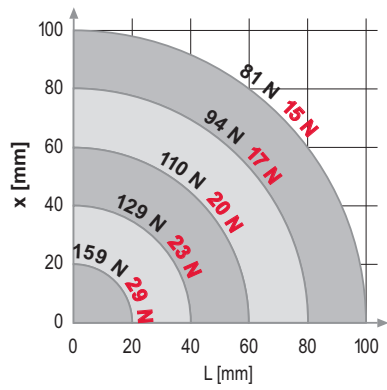

Centric - UG 25 NO opening

