

RN 331
HPP-25

Data sheet RN331-HPP

Bench Top Riveting Machine

Rivet shank Ø: up to 16 mm | Force: up to 33.00 kN | Stroke: up to 50 mm

Key features | Content of delivery

RN331-HPP Bench Top Riveting Machine

Forming process: Radial

Standard Version

- Nominal force 33 kN @ 6 bar (max. operating pressure)
- Rivet shaft up to Ø 16 mm (Steel 370 N/mm²)
- Spindle stroke 5 - 50 mm with 0.01mm micrometer scale and mechanical stroke limit
- Machine weight: approx. 250kg
- Electro-pneumatic drive - power supply @x@V, @Hz
- Permanently lubricated spindle
- Pressure cup & tool holder Rp=@ mm for forming tool length Ls=@ mm
- BFR-RN-331, Column, incl. height adjustment and table
- Color: light grey RAL 7035

Including

- HPP-010-331, Process Control HPP-25, connections X1, X2, X3, X20, X21
- Incl. SEI-100-331, Distance sensor, Type HPP-25
- Incl. SEI-200-331, Pressure sensors, Type HPP-25
- HPP-X4-01, Connection X4, incl. two-hand relays, for two-hand control and emergency-stop
- NSL-2HD-010, two-hand control via push button (w/out E-stop)
- SEI-OTH-331, Sensor upper spindle position (TDC)
- PNP-HPP-331, Pneumatic service unit and pneumatic control package for HPP
- NZ-201, Adjustable task light, 24 VDC, LED
- Manual grease press
- Standard accessories and user manual in the language of destination

Options

- NSL-2HD-011, Emergency-Stop (push button) for two-hand control
- SEI-UTE-000, Sensor for spindle in work position
- HPP-X5-01, Connection X5 PVM Module (for control of PNP-PRV-020)
- PNP-PRV-020, Proportional-pressure control, integrated & ready for operation (requires HPP-X5-01)
- HPP-X6-01, Connection X6, external safety / Reset
- NHE-MYC-U-02, Rivet base detection device NHE-U
- NHE-MST-xxx, NHE probe arm and probe (@)
- HPP-DLL-S7L-x, HPP-25 - Siemens S7 Communication link (S7LINK). License code to be ordered for each HPP control
- HPP-DLL-PCT, PC-Analysis Software HPP-PCTool, incl. UDP Protocol (on USB Stick)
- NZ-039, Automatic spindle lubrication system with lubricant level monitor

Subject to change.

Drawing

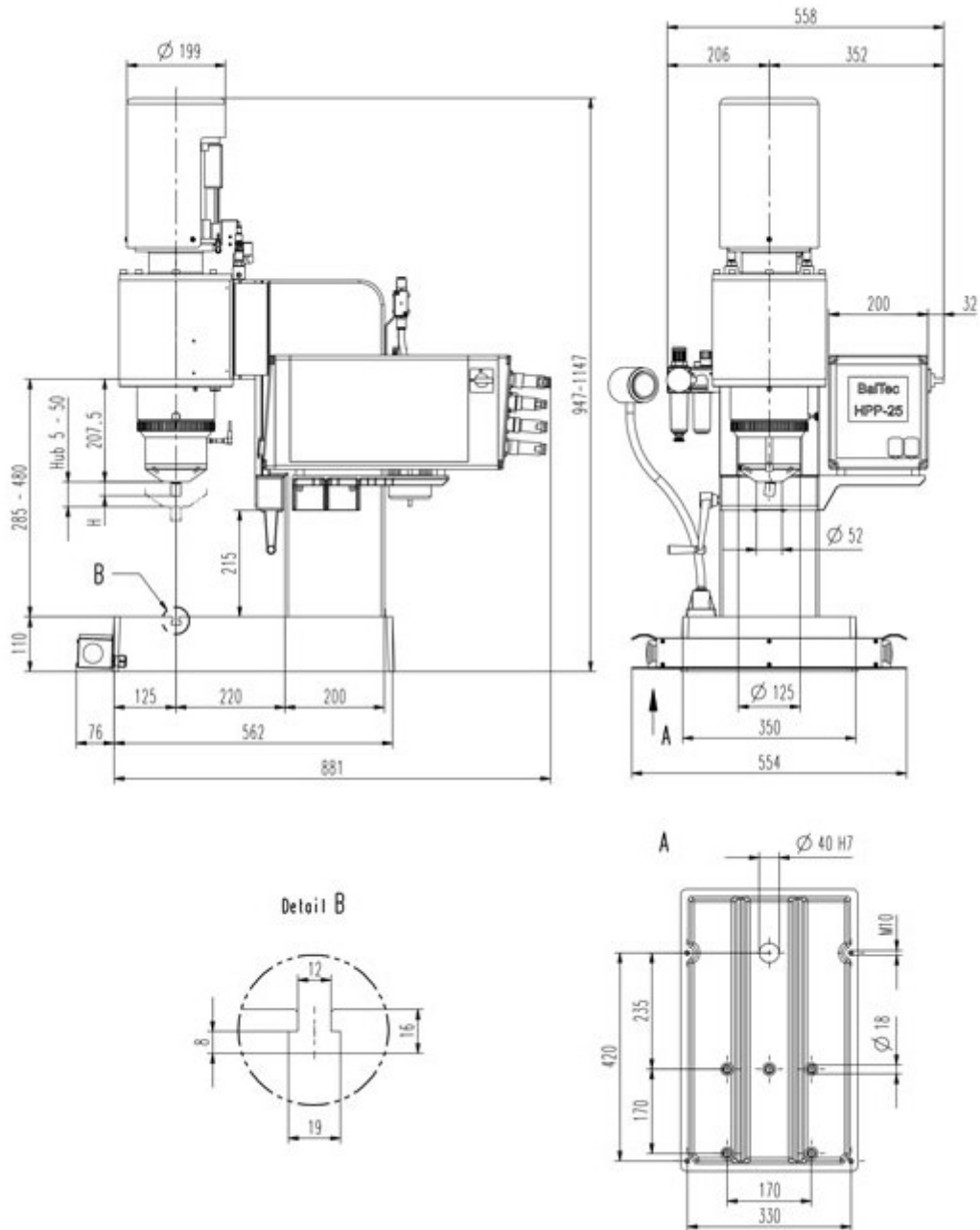

Forming tool lengths



Radius mm Rp	Tool length mm Ls	Free height mm H	Shank Ø mm Ds	Angle of inclination α
100.00	68.00	28.00	10	5° 37'
116.00	84.00	44.00	10	4° 47'
132.00	100.00	60.00	10	4° 10'
148.00	116.00	76.00	10	3° 41'
170.00	135.00	98.00	10	3° 10'
191.00	159.00	119.00	10	2° 49'
240.00	208.00	168.00	10	2° 13'

Forming tool profile



Our engineers are routinely meeting the demands of complex design problems. Having the specific tools needed for your metal forming project can mean the difference between success and failure. Contact us with your unique application for custom tooling.

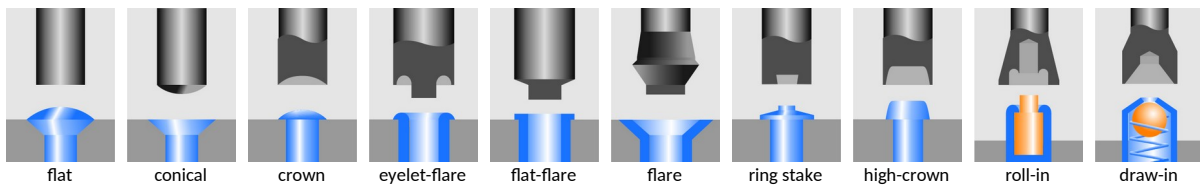

Industries & Applications



BalTec AG
Switzerland / Germany

BalTec (UK) Ltd.
United Kingdom

BalTec France
France

BalTec Corporation
USA / Canada / Mexico

BalTec do Brasil
Brazil

BalTec Machinery (Shanghai) Ltd.
China

BalTec Italia Srl
Italia

BalTec