

RN 181
RC-30

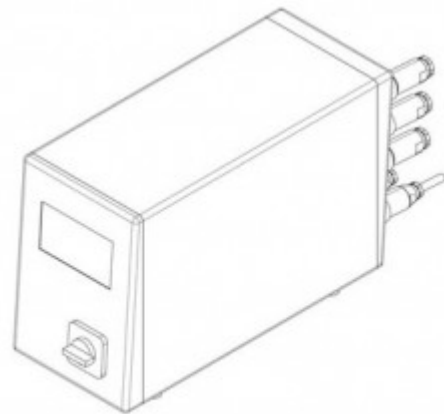

Data sheet RN181-RC3

Bench Top Riveting Machine

Rivet shank Ø: up to 6 mm | Force: up to 6.60 kN | Stroke: up to 30 mm

Key features | Content of delivery

RN181-RC3 Bench Top Riveting Machine

Forming process: Radial

Standard Version

- Nominal force 6.6 kN @ 6 bar (max. operating pressure)
- Rivet shaft up to Ø 6 mm (Steel 370 N/mm²)
- Spindle stroke 5 - 30 mm with 0.01mm micrometer scale and mechanical stroke limit
- Machine weight: approx. 65kg
- Electro-pneumatic drive - power supply @x@V, @Hz
- Permanently lubricated spindle
- Pressure cup & tool holder Rp=@mm for forming tool length Ls=@mm
- BFR-RN-181, Column, incl. height adjustment and table
- Color: light grey RAL 7035

Including

- RC3-010, RC-30 Time Based Control, connections X1, X2, X3, X20, X21
- RC3-X4-01, Connection X4, incl. two-hand relays, for Emergency-Stop and two-hand control
- NSL-2HD-010, two-hand control via push button, w/out emergency-stop
- PNP-010-181, Pneumatic service unit, lubrication and control package for RC-30
- NZ-201, Adjustable task light, 24 VDC, LED
- Manual grease press (is not supplied with automatic spindle lubrication system)
- Standard accessories and user manual in the language of destination

Options

- RC3-X5-01, Connection X5, incl. PVM Module
- RC3-X6-01, Connection X6, external safety / Reset
- SEI-OTH-181, Sensor upper spindle position (TDC)
- SEI-UTE-000, Sensor for spindle in work position
- NHE-MYC-E-01, Workpiece detection device NHE-E
- NHE-MST-xxx, NHE probe arm and probe (@)
- NZ-039, Automatic spindle lubrication system with lubricant level monitor
- NSL-2HD-011, Emergency-Stop (push button) for two-hand control

Subject to change.

Drawing

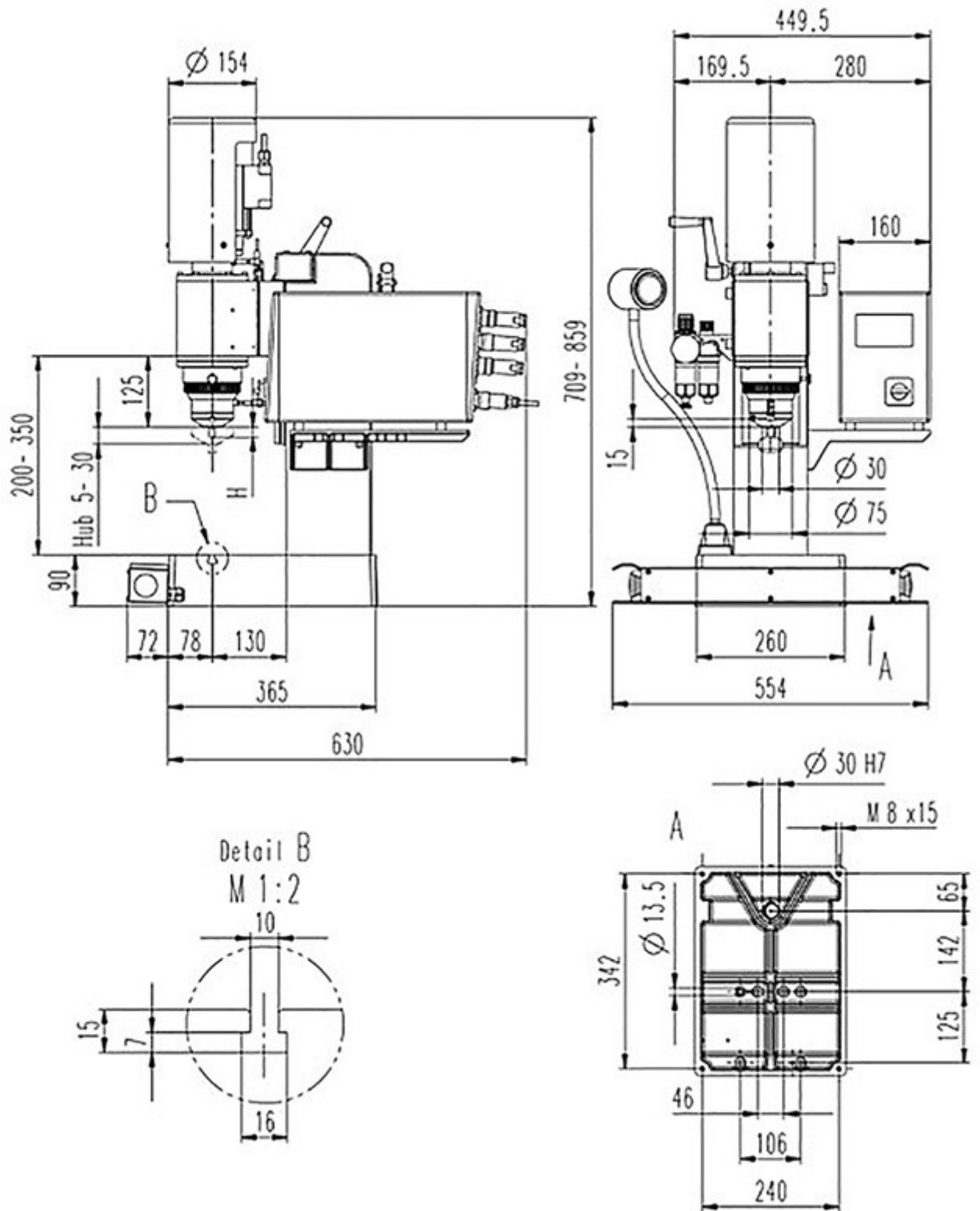

Forming tool lengths

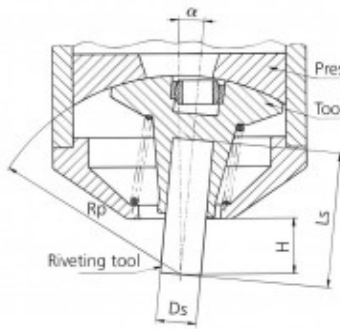

Radius mm Rp	Tool length mm Ls	Free height mm H	Shank Ø mm Ds	Angle of inclination α
65.00	39.00	18.00	10	6° 02'
80.00	54.00	33.00	10	4° 47'
100.00	74.00	53.00	10	3° 44'
120.00	94.00	73.00	10	3° 04'
132.00	106.00	85.00	10	2° 46'

Forming tool profile



Our engineers are routinely meeting the demands of complex design problems. Having the specific tools needed for your metal forming project can mean the difference between success and failure. Contact us with your unique application for custom tooling.

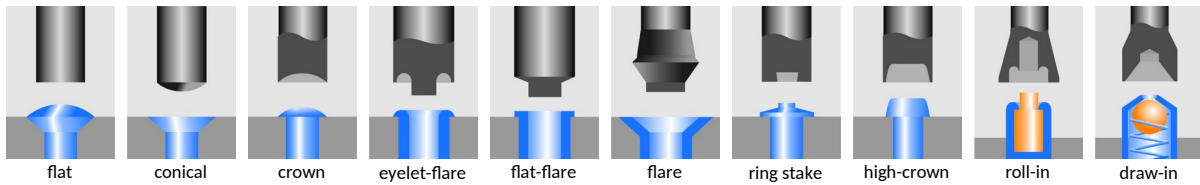

Industries & Applications



BalTec AG
Switzerland / Germany

BalTec (UK) Ltd.
United Kingdom

BalTec France
France

BalTec Corporation
USA / Canada / Mexico

BalTec do Brasil
Brazil

BalTec Machinery (Shanghai) Ltd.
China

BalTec Italia Srl
Italia

BalTec