

RNE 381

## Data sheet RNE-010-381

Radial Riveting Unit

Rivet shank Ø: up to 20 mm | Force: up to 40.00 kN | Stroke: up to 50 mm

## Key features | Content of delivery

### RNE-010-381 Radial Riveting Unit

#### Forming process: Radial

#### Standard Version

- Nominal force 40 kN @ 65 bar (max. operating pressure)
- Rivet shaft up to Ø 20 mm (Steel 370 N/mm<sup>2</sup>)
- Spindle stroke 5-50 mm with 0.01 mm micrometer scale and mechanical stroke limit
- Machine weight: approx. 80 kg
- Hydraulic pack weight (empty): approx. 54kg
- Electro-hydraulic drive - power supply @x@V, @Hz
- Permanently lubricated spindle
- Pressure cup & tool holder Rp = @ mm for forming tool length Ls = @ mm
- Color: light grey RAL 7035

#### Including

- Manual grease gun (not supplied if automatic lubrication is ordered)
- Standard accessories and user manual in the language of destination

#### Options

- SEI-OTH-381 Sensor upper spindle home position (TDC)
- NHE-MYC-E-02, Rivet base detection device NHE-E
- NHE-MST-xxx, RBD lever and touch sleeve (@)
- NZ-039, Automatic lubrication with reservoir grease level monitor

Subject to change.

## Drawing

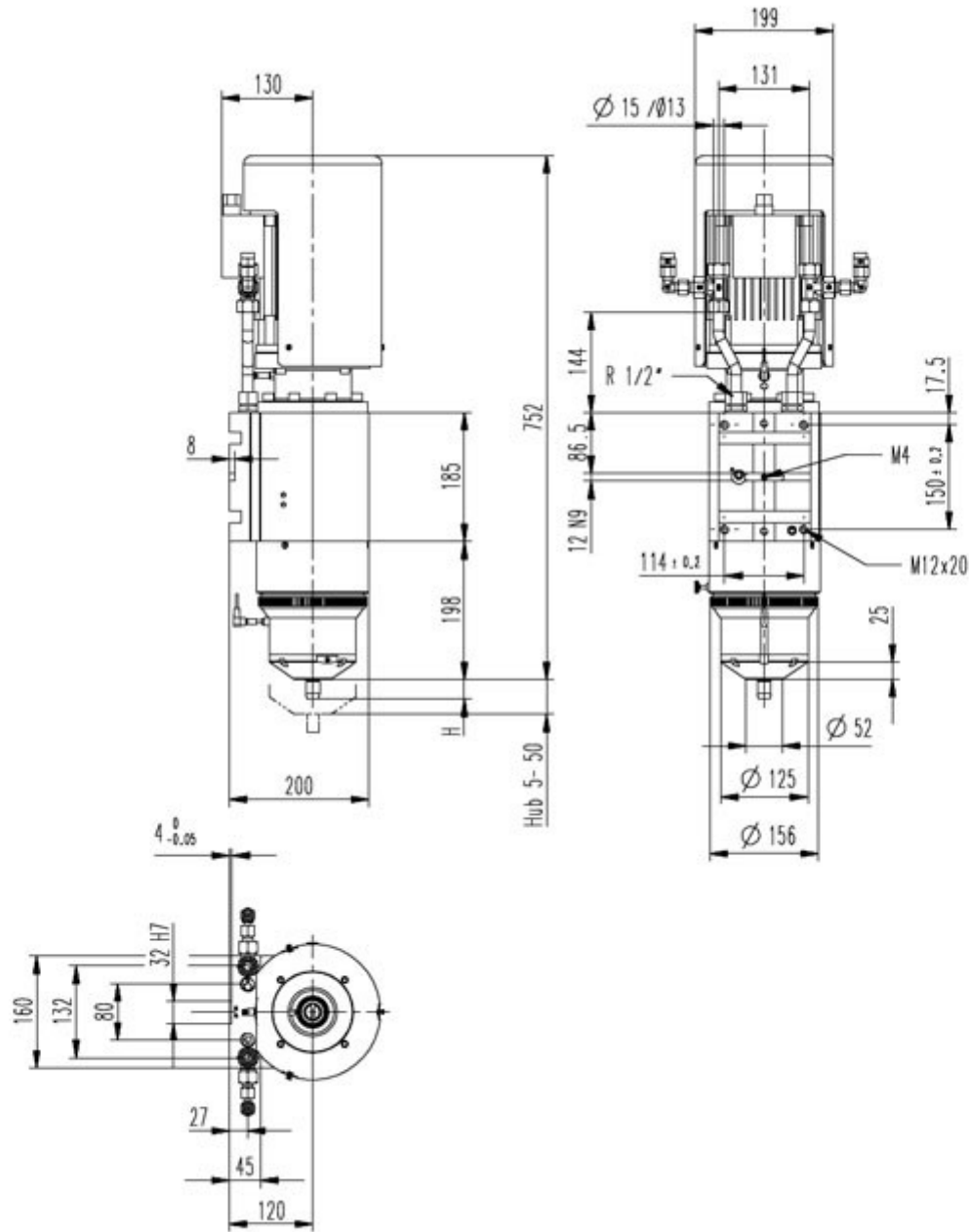

## Forming tool lengths



Radius mm Rp	Tool length mm Ls	Free height mm H	Shank Ø mm Ds	Angle of inclination α
100.00	68.00	28.00	10	5° 37'
116.00	84.00	44.00	10	4° 47'
132.00	100.00	60.00	10	4° 10'
148.00	116.00	76.00	10	3° 41'
170.00	135.00	98.00	10	3° 10'
191.00	159.00	119.00	10	2° 49'
240.00	208.00	168.00	10	2° 13'

## Forming tool profile



Our engineers are routinely meeting the demands of complex design problems. Having the specific tools needed for your metal forming project can mean the difference between success and failure. Contact us with your unique application for custom tooling.

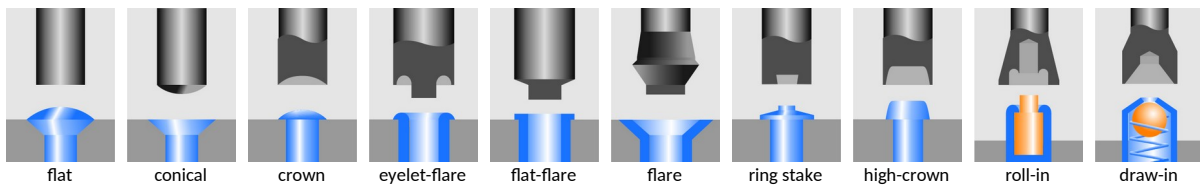

## Industries & Applications



**BalTec AG**  
Switzerland / Germany

BalTec (UK) Ltd.  
United Kingdom

BalTec France  
France

BalTec Corporation  
USA / Canada / Mexico

BalTec do Brasil  
Brazil

BalTec Machinery (Shanghai) Ltd.  
China

BalTec Italia Srl  
Italia

# BalTec