

RNE 281

Data sheet RNE-010-281

Radial Riveting Unit

Rivet shank Ø: up to 12 mm | Force: up to 17.00 kN | Stroke: up to 40 mm

Key features | Content of delivery

RNE-010-281 Radial Riveting Unit

Forming process: Radial

Standard Version

- Nominal force 17 kN @ 6 bar (max. operating pressure)
- Rivet shaft up to Ø 12 mm (Steel 370 N/mm²)
- Spindle stroke 5-40 mm with 0.01 mm micrometer scale and mechanical stroke limit
- Machine weight: approx. 60 kg
- Electro-pneumatic drive - power supply @x@V, @Hz
- Permanently lubricated spindle
- Pressure cup & tool holder Rp = @ mm for forming tool length Ls = @ mm
- Color: light grey RAL 7035

Including

- Manual grease gun (not supplied if automatic lubrication is ordered)
- Standard accessories and user manual in the language of destination

Options

- SEI-OTH-281 Sensor upper spindle home position (TDC)
- NHE-MYC-E-02, Rivet base detection device NHE-E
- NHE-MST-xxx, RBD lever and touch sleeve (@)
- NZ-039, Automatic lubrication with reservoir grease level monitor

Subject to change.

Drawing

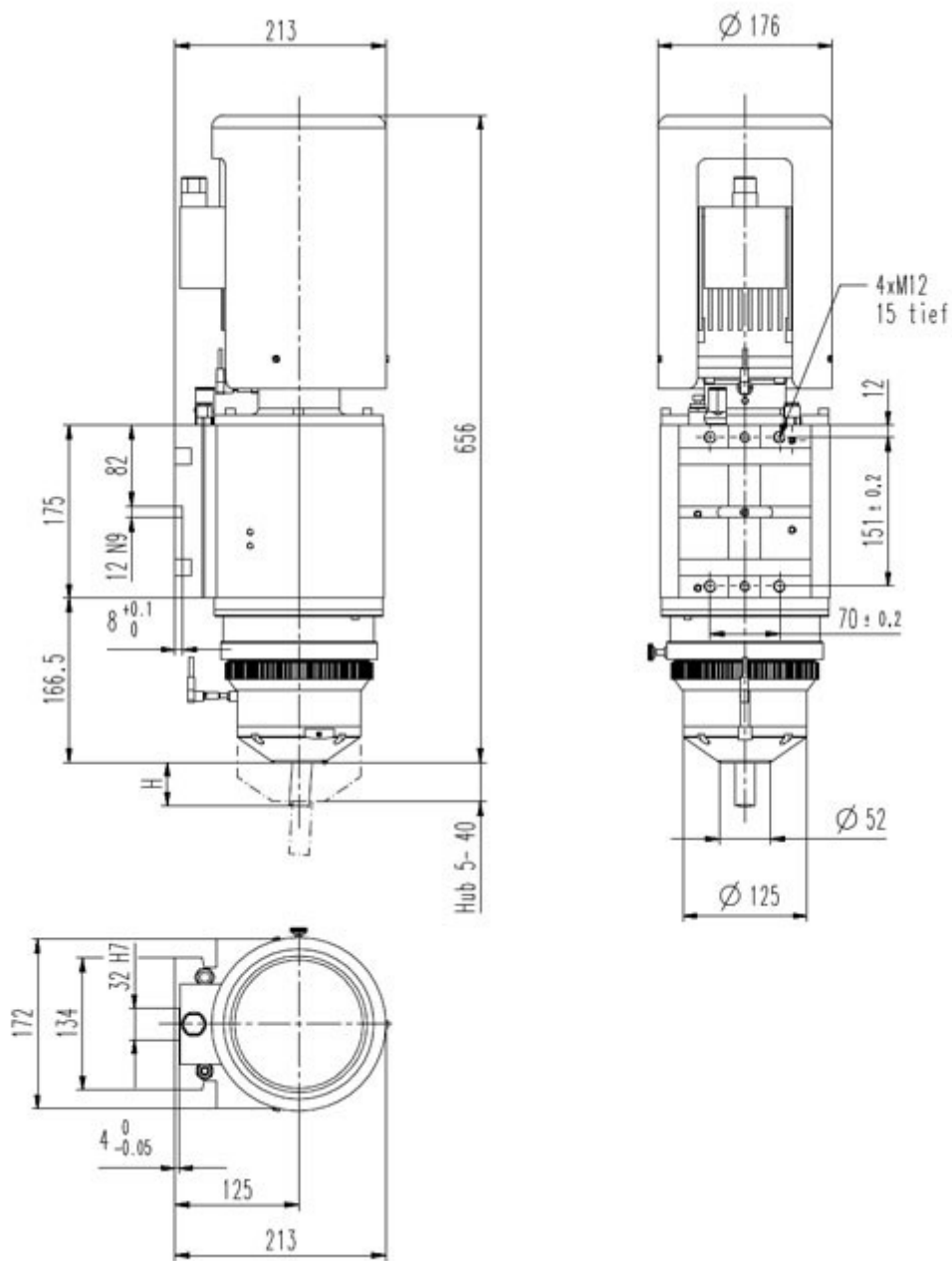

Forming tool lengths

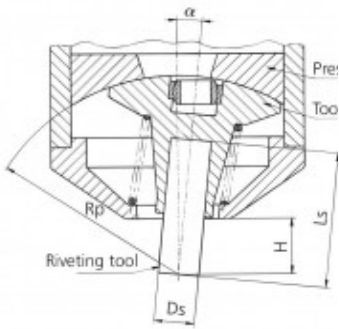

Radius mm Rp	Tool length mm Ls	Free height mm H	Shank Ø mm Ds	Angle of inclination α
100.00	68.00	28.00	10	5° 37'
116.00	84.00	44.00	10	4° 47'
132.00	100.00	60.00	10	4° 10'
148.00	116.00	76.00	10	3° 41'
170.00	135.00	98.00	10	3° 10'
191.00	159.00	119.00	10	2° 49'
240.00	208.00	168.00	10	2° 13'

Forming tool profile



Our engineers are routinely meeting the demands of complex design problems. Having the specific tools needed for your metal forming project can mean the difference between success and failure. Contact us with your unique application for custom tooling.

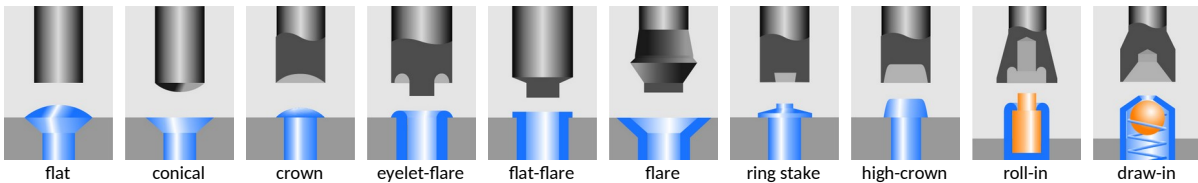

Industries & Applications



BalTec AG
Switzerland / Germany

BalTec (UK) Ltd.
United Kingdom

BalTec France
France

BalTec Corporation
USA / Canada / Mexico

BalTec do Brasil
Brazil

BalTec Machinery (Shanghai) Ltd.
China

BalTec Italia Srl
Italia

BalTec