

RNE 281
HPP-25

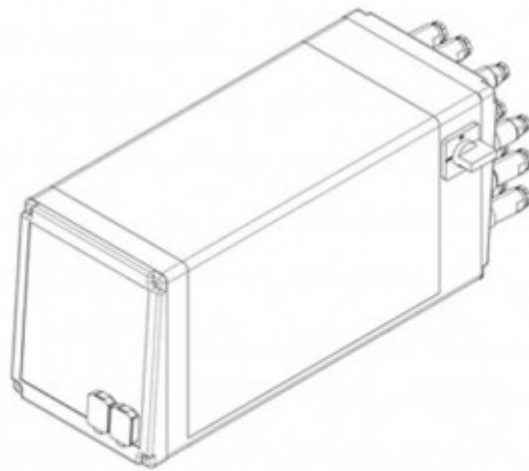

Data sheet RNE281-HPP

Riveting Unit

Rivet shank Ø: up to 12 mm | Force: up to 17.00 kN | Stroke: up to 40 mm

Key features | Content of delivery

RNE281-HPP Riveting Unit

Forming process: Radial

Standard Version

- Nominal force 17 kN @ 6 bar (max. operating pressure)
- Rivet shaft up to Ø 12 mm (Steel 370 N/mm²)
- Spindle stroke 5 - 40 mm with 0.01 mm micrometer scale and mechanical stroke limit
- Machine weight: approx. 75 kg
- Electro-pneumatic drive - power supply @x@V, @Hz
- Permanently lubricated spindle
- Pressure cup & tool holder Rp=@ mm for forming tool length Ls=@ mm
- Color: light grey RAL 7035

Including

- HPP-010-281, Process-Control HPP-25, connections X1, X2, X3, X20, X21; The measurements of the HPP-25 process control are additionally: (W x H X D in mm) 232 x 243 x 581
- Incl. SEI-100-281, Distance sensor, Type HPP-25
- Incl. SEI-200-281, Pressure sensors, Type HPP-25
- HPP-X4-02, Connection X4, for emergency-stop, w/out two-hand relay
- HPP-X6-01, Connection X6, external safety / reset
- HPP-X9-01, Connection X9, PLC interface with cable, 5m
- HPP-045-03, Sensor cable extension 3 m, total length 4 m
- SEI-OTH-281, Sensor upper spindle home position (TDC)
- PNP-HPP-281, Pneumatic service unit and pneumatic control package for HPP
- NZ-039, Automatic lubrication with reservoir grease level monitor
- Standard accessories and user manual in the language of destination

Options

- HPP-X5-01, Connection X5 PVM Module in HPP (for control of PNP-PRV-020)
- PNP-PRV-020, Proportional-Pressure control integrated & ready for operation (requires HPP-X5-01)
- NHE-MYC-U-02, Rivet base detection device NHE-U
- NHE-MST-xxx, RBD lever and touch sleeve (@)
- HPP-DLL-S7L-x, HPP-25 - Siemens S7 Communication link (S7LINK). License code to be ordered for each HPP control
- HPP-DLL-PCT, PC-Analysis Software HPP-PCTool, incl. UDP Protocol (on USB Stick)

Subject to change.

Drawing

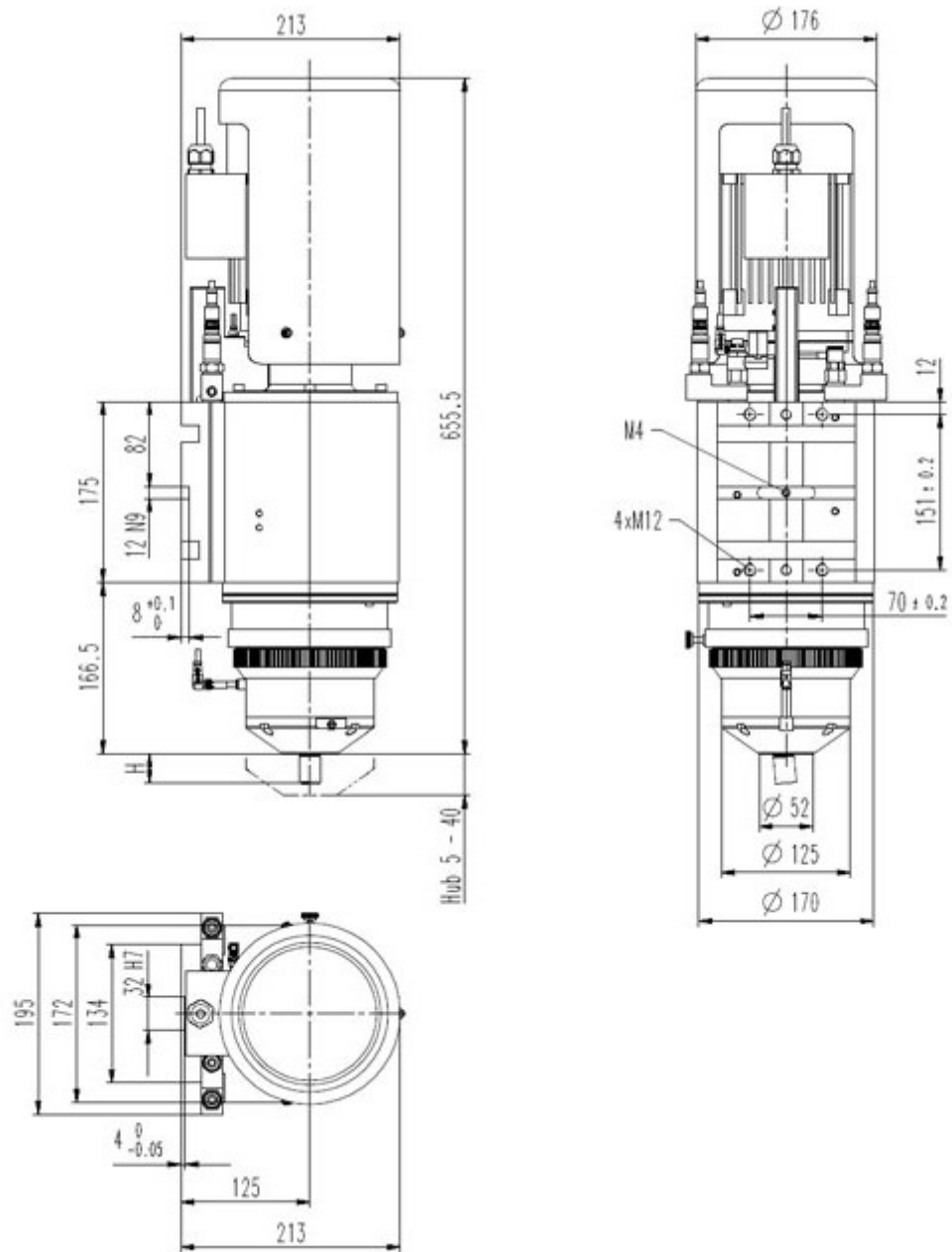

Forming tool lengths

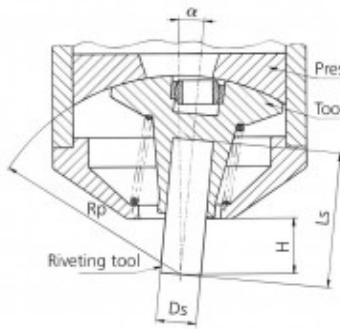

Radius mm Rp	Tool length mm Ls	Free height mm H	Shank Ø mm Ds	Angle of inclination α
100.00	68.00	28.00	10	5° 37'
116.00	84.00	44.00	10	4° 47'
132.00	100.00	60.00	10	4° 10'
148.00	116.00	76.00	10	3° 41'
170.00	135.00	98.00	10	3° 10'
191.00	159.00	119.00	10	2° 49'
240.00	208.00	168.00	10	2° 13'

Forming tool profile



Our engineers are routinely meeting the demands of complex design problems. Having the specific tools needed for your metal forming project can mean the difference between success and failure. Contact us with your unique application for custom tooling.

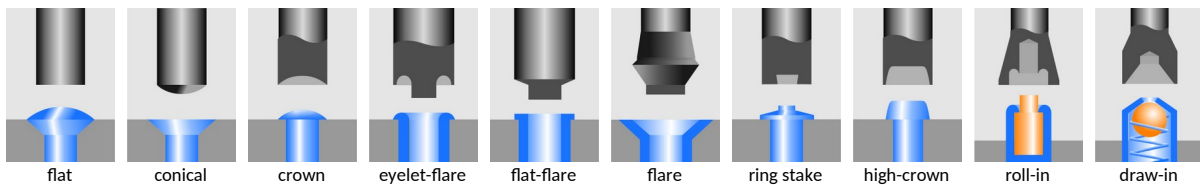

Industries & Applications



BalTec AG
Switzerland / Germany

BalTec (UK) Ltd.
United Kingdom

BalTec France
France

BalTec Corporation
USA / Canada / Mexico

BalTec do Brasil
Brazil

BalTec Machinery (Shanghai) Ltd.
China

BalTec Italia Srl
Italia

BalTec