

# Cables



## Table of contents: Cables

<b>Cables</b>	<b>Page</b>
Motor cables	153
Encoder cables	161
Proximity switch cables	167
Power cables	171
Sensor-actuator cables	172

Motor cables	2 m	3 m	4 m	5 m	6 m	8 m	10 m
M5- .... -0-open-1				50075693			50224179
M10- .... -0-open-1				50219768			50249065
M12- .... -0-open-1				50290459			50310506
M12- .... -90-open-1				50290460			50310507
M13- .... -0-open-1				50311326			50311327
M14- .... -0-0-1		50311491		50341510			
M15- .... -0-0-1		50332418		50338977			
M15- .... -90-0-1		50332420		50338978			
M16- .... -0-1-X			50463073		50463076	50463078	
M16- .... -0-1-1			50437168		50437167	50427023	
Extension M16- .... -0-0-1	50450944		50427026		50463082		
Extension M16- .... -0-0-2	50463081						
M17- .... -0-1-1			50437170		50437169	50427021	
Extension M17- .... -0-0-1	50463084		50427024		50463087		
Extension M17- .... -0-0-2	50463085		50463086				
M18- .... -0-open				50450380			50446251
M19- .... -0-0-1		50459733		50459734			
M20- .... -0-2-X			50463088		50463090	50463092	
M20- .... -0-2-1			50463089		50463091	50463093	
M22- .... -0-2-1			50463100		50463101	50463103	
M23- .... -0-1-X			50463104		50463105	50463106	
M24- .... -0-2-X			50463107		50463108	50463109	
M27- .... -0-open-1				50545333			50545334
M27- .... -90-open-1				50545335			50545336

Encoder cables	2 m	3 m	4 m	5 m	6 m	8 m	10 m
G5-.... -0-0-1				50075695			50224183
G6- .... -0-0-1				50100693			50224185
G10- .... -0-0-1				50297199			50310508
G10- .... -90-0-1				50297200			50310509
G11- .... -0-0-1				50311323			50311325
G12- .... -0-0-1		50332416		50338975			
G12- .... -90-0-1		50332417		50338976			
G14- .... -0-0-1		50443145		50439300			50450518
G14- .... -90-0-1		50450519		50450520			50450521
G16- .... -0-0-1				50450376			50446252
G17- .... -0-0-1				50450378			50450379
G18- .... -0-0-1							50468310
G18- .... -90-0-1							50468311
Extension G18- .... -0-0-1	50468312			50468313			
G19- .... -0-0-1							50468314
G19- .... -90-0-1							50468315

Proximity switch cables	0.1 m	0.6 m	1.5 m	2 m	3 m	5 m	10 m
R1- .... -0-open-1				11006443	50340925	11006446	50072072
R1- .... -90-open-1				11006447	50340954	11007826	50310513
R2- .... -0-0-1		11015003			50340271	11017754	
R2- .... -90-0-1					50340272	50340903	
R3- .... -0-open-1				11006428		11006431	50098553
R3- .... -90-open-1				11006429		11006430	
R6- .... -0-0-1			50164838				
R9- .... -0-0-1					50341476	50341478	
R10- .... -0-0-1	50386489						

Sensor-actuator cable	0.1 m	0.6 m	1.5 m	2 m	3 m	5 m	10 m
S1-0-open		50512492					
S2-0-open						50512467	
S3-0-open				50359710		11007828	
S3-90-open				50551477		50551478	

**Cable nomenclature:**

Cable designation - Cable type - Cable length - Plug, module side - Plug, controller side - Cable type

**e. g. Motor cable-M5-5m-0-open-1:**

**Cable designation:**

- M: Motor cable
- G: Encoder cable
- R: Proximity switch cable
- S: Sensor-actuator cable

**Cable type:**

M5: Cable type

**Cable length:**

5m: Cable length in m

**Plug, module side:**

- 0: Plug, straight
- 90: Plug, 90° angle

**Plug, controller side:**

- 0: Plug, straight
- 1: Plug, straight/motor phases with additional plug
- 2: Plug, straight/motor phases open
- 3: Plug, straight/open wires
- open: open wires

**Cable type**

- X: Non-moving transfer
- 1: Moving transfer, drag chain
- 2: Moving transfer, robot

# Cables

Motor cable-M5	5m-0-open-1	10m-0-open-1
<b>Order number</b>	<b>50075693</b>	<b>50224179</b>
Net weight	0.2 kg	0.4 kg
Cable Ø	11.2 mm	11.3 mm
Min. bending radii	90 mm	90 mm
Material	PUR	PUR
A	5 m	10 m

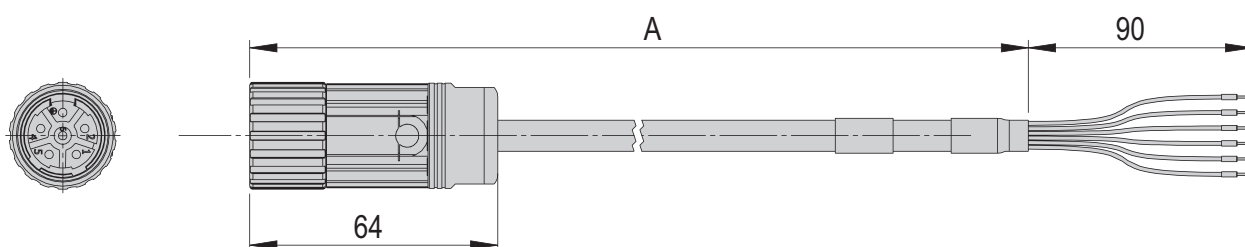

Motor cable-M10	5m-0-open-1	10m-0-open-1
<b>Order number</b>	<b>50219768</b>	<b>50249065</b>
Net weight	0.6 kg	1.1 kg
Cable Ø	10 mm	10 mm
Min. bending radii	90 mm	90 mm
Material	PUR	PUR
A	5 m	10 m

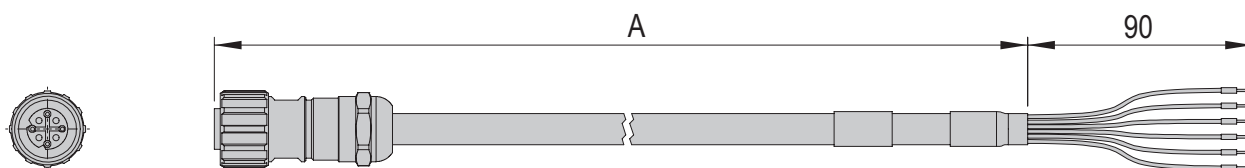

# Cables

Motor cable-M12	5m-0-open-1	10m-0-open-1
<b>Order number</b>	<b>50290459</b>	<b>50310506</b>
Net weight	0.1 kg	0.2 kg
Cable Ø	6 mm	6 mm
Min. bending radii	90 mm	90 mm
Material	PUR	PUR
A	5 m	10 m

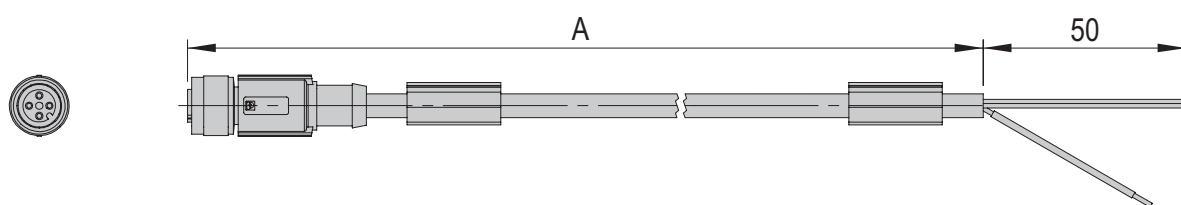

10

Motor cable-M12-90	5m-90-open-1	10m-90-open-1
<b>Order number</b>	<b>50290460</b>	<b>50310507</b>
Net weight	0.1 kg	0.2 kg
Cable Ø	6 mm	6 mm
Min. bending radii	90 mm	90 mm
Material	PUR	PUR
A	5 m	10 m

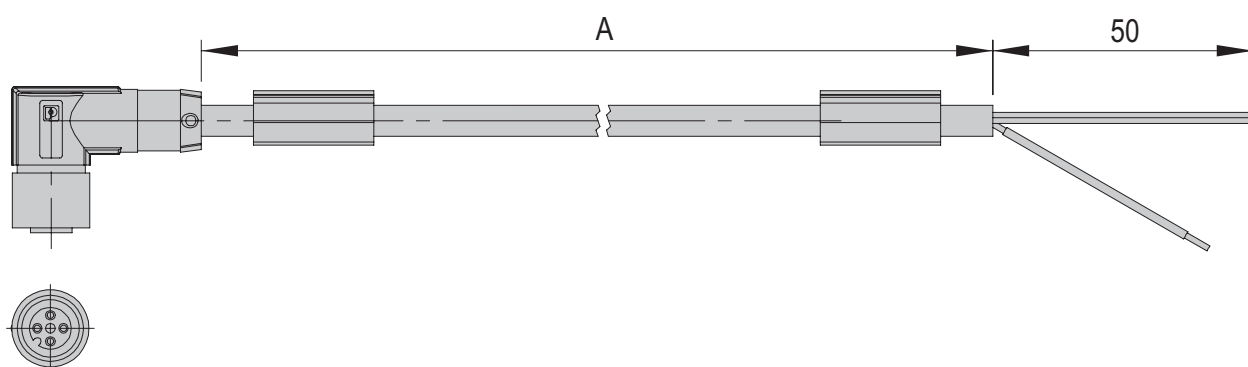

# Cables

Motor cable-M13	5m-0-open-1	10m-0-open-1
<b>Order number</b>	<b>50311326</b>	<b>50311327</b>
Net weight	0.2 kg	0.4 kg
Cable Ø	11.3 mm	11.3 mm
Min. bending radii	90 mm	90 mm
Material	PUR	PUR
A	5 m	10 m

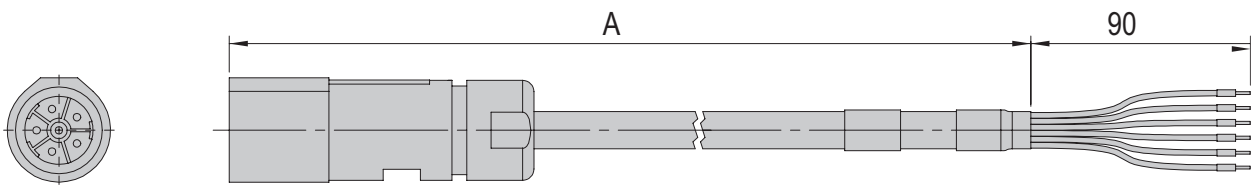

Motor cable-M14	3m-0-0-1	5m-0-0-1
<b>Order number</b>	<b>50311491</b>	<b>50341510</b>
Net weight	0.3 kg	0.5 kg
Cable Ø	7 mm	7 mm
Min. bending radii	90 mm	90 mm
Material	PUR	PUR
A	3 m	5 m

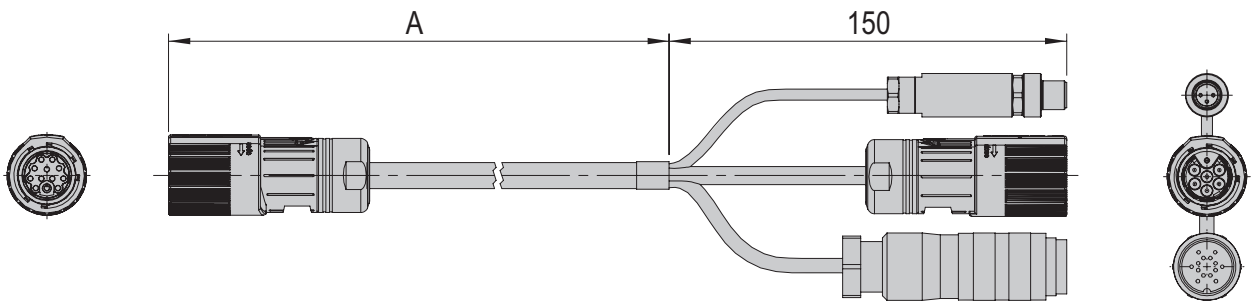

Motor cable-M15	3m-0-0-1	5m-0-0-1
<b>Order number</b>	<b>50332418</b>	<b>50338977</b>
Net weight	0.2 kg	0.3 kg
Cable Ø	6 mm	6 mm
Min. bending radii	90 mm	90 mm
Material	PUR	PUR
A	3 m	5 m

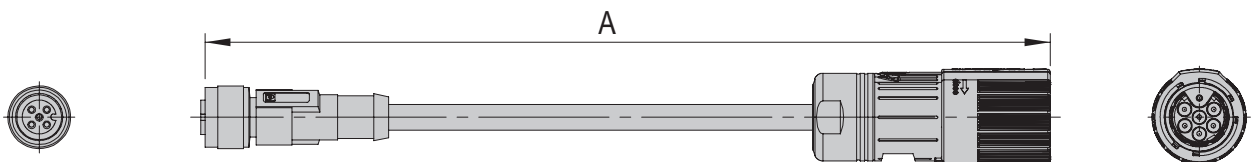

# Cables

Motor cable-M15-90	3m-90-0-1	5m-90-0-1
<b>Order number</b>	<b>50332420</b>	<b>50338978</b>
Net weight	0.1 kg	0.2 kg
Cable Ø	6 mm	6 mm
Min. bending radii	90 mm	90 mm
Material	PUR	PUR
A	3 m	5 m

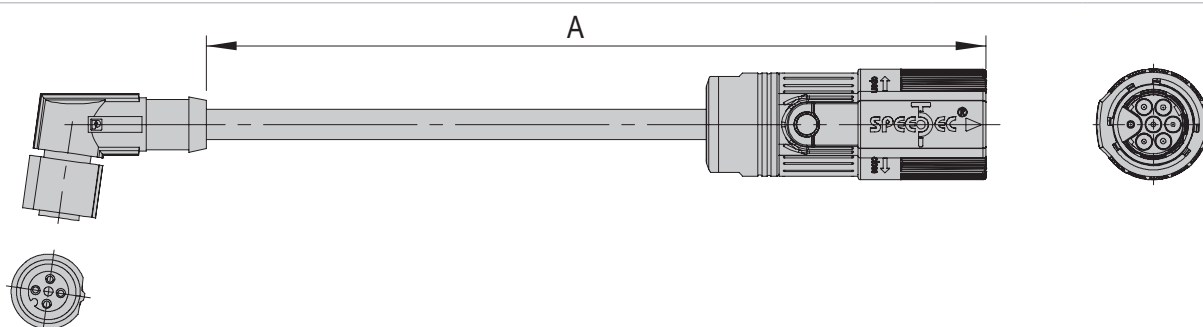

10

Motor cable-M16-0-1-X	4m-0-1-X	6m-0-1-X	8m-0-1-X
<b>Order number</b>	<b>50463073</b>	<b>50463076</b>	<b>50463078</b>
Net weight	0.6 kg	0.9 kg	1.2 kg
Cable Ø	8.2 mm	8.2 mm	8.2 mm
Min. bending radii	static 25 mm	static 25 mm	static 25 mm
Material	PUR	PUR	PUR
A	4 m	6 m	8 m

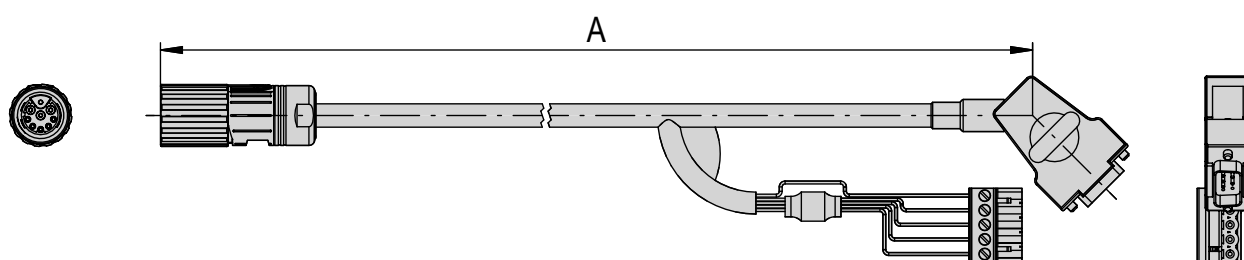

Motor cable M16-0-1-1	4m-0-1-1	6m-0-1-1	8m-0-1-1
<b>Order number</b>	<b>50437168</b>	<b>50437167</b>	<b>50427023</b>
Net weight	0.6 kg	0.9 kg	1.2 kg
Cable Ø	9.5 mm	9.5 mm	9.5 mm
Min. bending radii	60 mm	60 mm	60 mm
Material	PUR	PUR	PUR
A	4 m	6 m	8 m

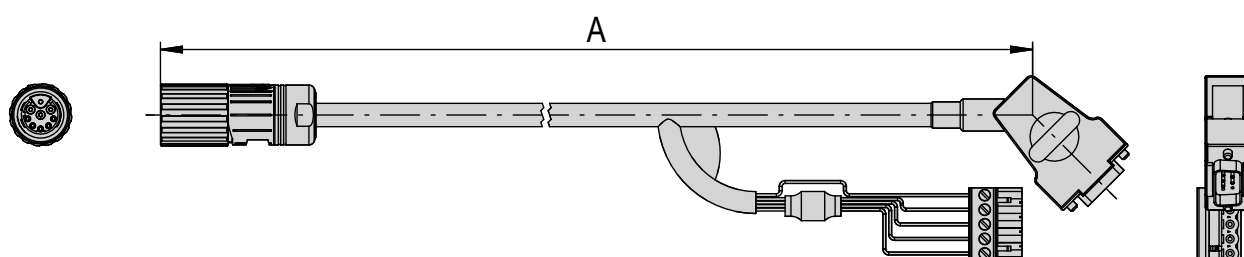



# Cables

Motor cable extension for M16-0-0-1/2	2m-0-0-1	4m-0-0-1	6m-0-0-1	2m-0-0-2
<b>Order number</b>	<b>50450944</b>	<b>50427026</b>	<b>50463082</b>	<b>50463081</b>
Net weight	0.3 kg	0.6 kg	0.9 kg	0.2 kg
Cable Ø	9.5 mm	9.5 mm	9.5 mm	9.7 mm
Min. bending radii	60 mm	60 mm	60 mm	60 mm
Material	PUR	PUR	PUR	PUR
A	2 m	4 m	6 m	2 m

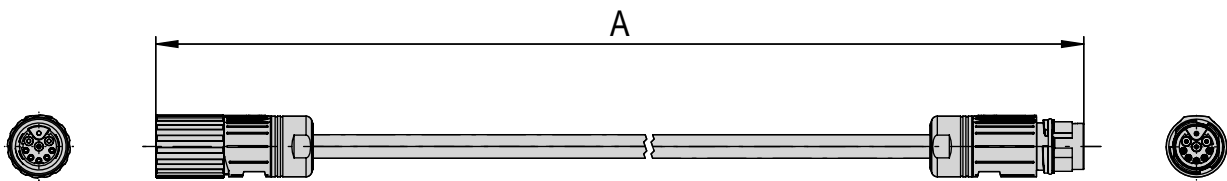

Motor cable-M17-0-1-1	4m-0-1-1	6m-0-1-1	8m-0-1-1
<b>Order number</b>	<b>50437170</b>	<b>50437169</b>	<b>50427021</b>
Net weight	0.6 kg	0.8 kg	1.1 kg
Cable Ø	10.8 mm	10.8 mm	10.8 mm
Min. bending radii	100 mm	100 mm	100 mm
Material	PUR	PUR	PUR
A	4 m	6 m	8 m

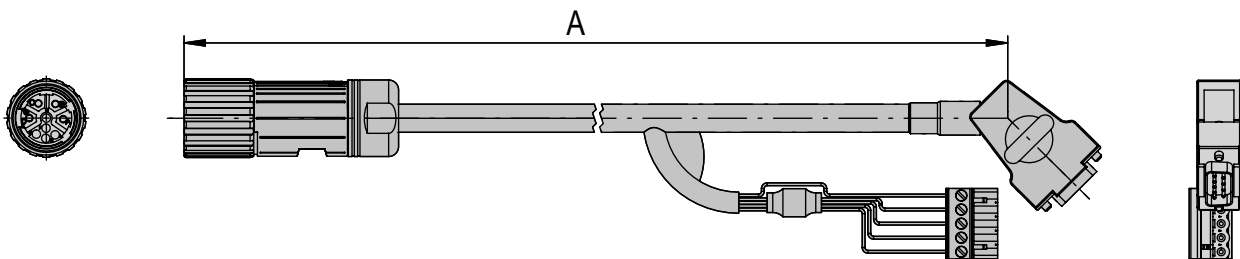

Motor cable extension for M17-0-0-1/2	2m-0-0-1	4m-0-0-1	6m-0-0-1	2m-0-0-2	4m-0-0-2
<b>Order number</b>	<b>50463084</b>	<b>50427024</b>	<b>50463087</b>	<b>50463085</b>	<b>50463086</b>
Net weight	0.4 kg	0.8 kg	1.2 kg	0.4 kg	0.8 kg
Cable Ø	10.8 mm	10.8 mm	10.8 mm	10.9 mm	10.9 mm
Min. bending radii	100 mm	100 mm	100 mm	100 mm	100 mm
Material	PUR	PUR	PUR	PUR	PUR
A	2 m	4 m	6 m	2 m	4 m

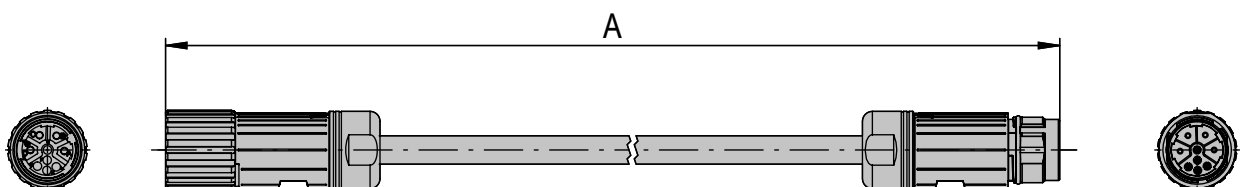

# Cables

Motor cable-M18	5m-0-open-1	10m-0-open-1
<b>Order number</b>	<b>50450380</b>	<b>50446251</b>
Net weight	0.5 kg	0.6 kg
Cable Ø	10.2 mm	10.2 mm
Min. bending radii	120 mm	120 mm
Material	PUR	PUR
A	5 m	10 m

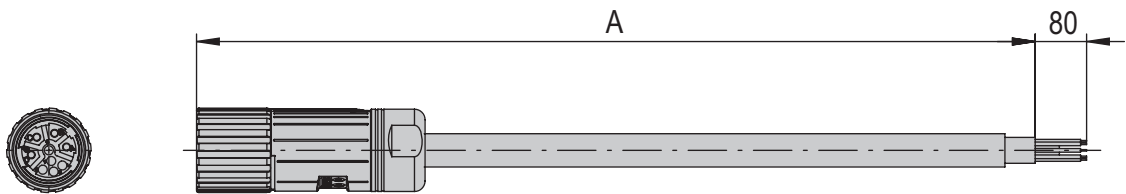

10

Motor cable-M19-0-0-1	3m-0-0-1	5m-0-0-1
<b>Order number</b>	<b>50459733</b>	<b>50459734</b>
Net weight	1 kg	1.3 kg
Cable Ø	8.3 mm	8.3 mm
Min. bending radii	90 mm	90 mm
Material	PUR	PUR
A	3 m	5 m

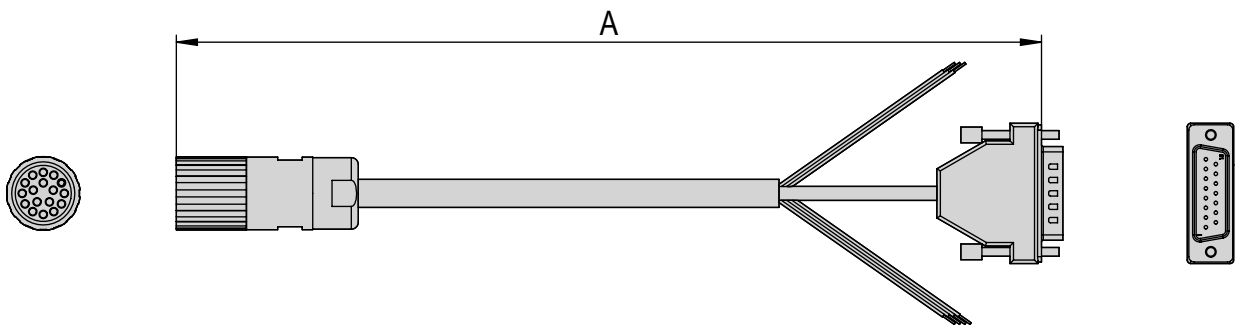

Motor cable-M20-0-2-X	4m-0-2-X	6m-0-2-X	8m-0-2-X
<b>Order number</b>	<b>50463088</b>	<b>50463090</b>	<b>50463092</b>
Net weight	0.6 kg	0.9 kg	1.2 kg
Cable Ø	8.2 mm	8.2 mm	8.2 mm
Min. bending radii	static 25 mm	static 25 mm	static 25 mm
Material	PUR	PUR	PUR
A	4 m	6 m	8 m

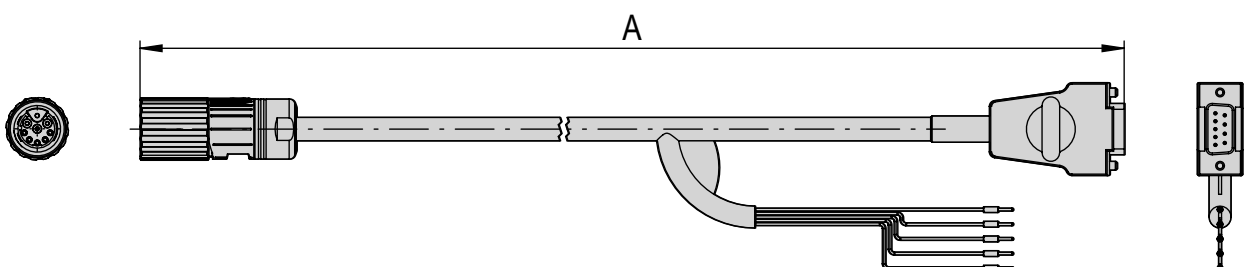

# Cables

Motor cable-M20-0-2-1	4m-0-2-1	6m-0-2-1	8m-0-2-1
<b>Order number</b>	<b>50463089</b>	<b>50463091</b>	<b>50463093</b>
Net weight	0.6 kg	1 kg	1.3 kg
Cable Ø	9.5 mm	9.5 mm	9.5 mm
Min. bending radii	60 mm	60 mm	60 mm
Material	PUR	PUR	PUR
A	4 m	6 m	8 m

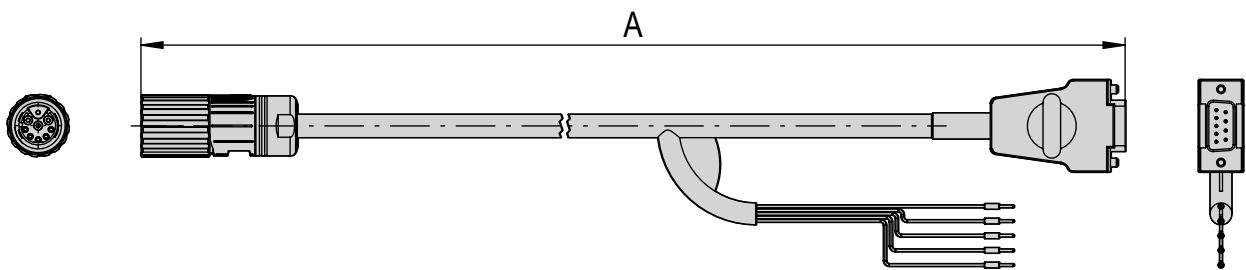

Motor cable-M22-0-2-1	4m-0-2-1	6m-0-2-1	8m-0-2-1
<b>Order number</b>	<b>50463100</b>	<b>50463101</b>	<b>50463103</b>
Net weight	0.7 kg	1.1 kg	1.4 kg
Cable Ø	10.8 mm	10.8 mm	10.8 mm
Min. bending radii	100 mm	100 mm	100 mm
Material	PUR	PUR	PUR
A	4 m	6 m	8 m

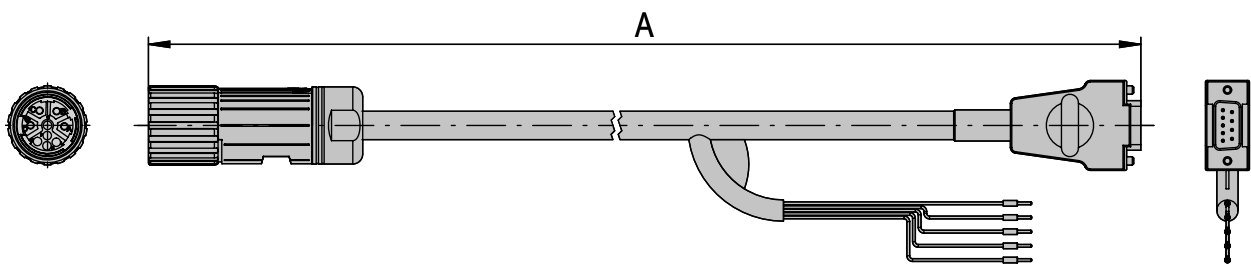

Motor cable-M23-0-1-X	4m-0-1-X	6m-0-1-X	8m-0-1-X
<b>Order number</b>	<b>50463104</b>	<b>50463105</b>	<b>50463106</b>
Net weight	1 kg	1.5 kg	2 kg
Cable Ø	11.2 mm	11.2 mm	11.2 mm
Min. bending radii	static 50 mm	static 50 mm	static 50 mm
Material	PUR	PUR	PUR
A	4 m	6 m	8 m

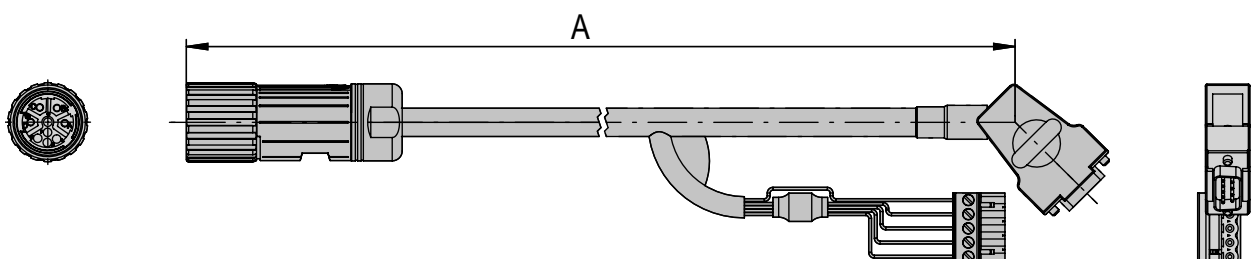

# Cables

Motor cable-M24-0-2-X	4m-0-2-X	6m-0-2-X	8m-0-2-X
<b>Order number</b>	<b>50463107</b>	<b>50463108</b>	<b>50463109</b>
Net weight	1 kg	1.5 kg	2 kg
Cable Ø	11.2 mm	11.2 mm	11.2 mm
Min. bending radii	50 mm	50 mm	50 mm
Material	PUR	PUR	PUR
A	4 m	6 m	8 m

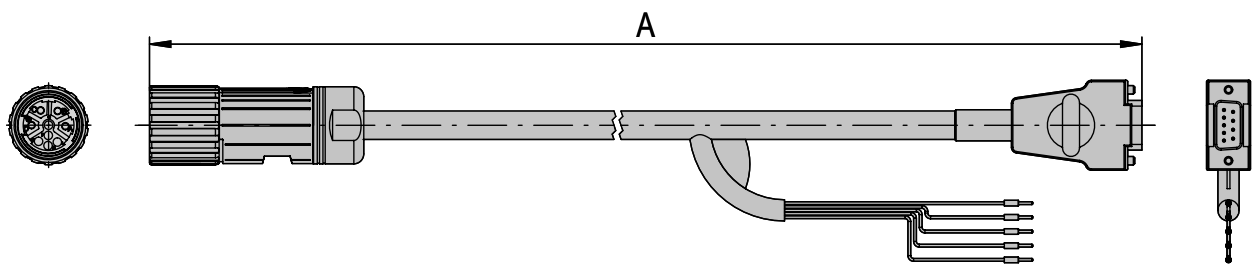

10

Motor cable-M27	5m-0-open-1	10m-0-open-1
<b>Order number</b>	<b>50545333</b>	<b>50545334</b>
Net weight	0.75 kg	1.47 kg
Cable Ø	9.7 mm	9.7 mm
Min. bending radii	97 mm	97 mm
Material	PUR	PUR
A	5 m	10 m

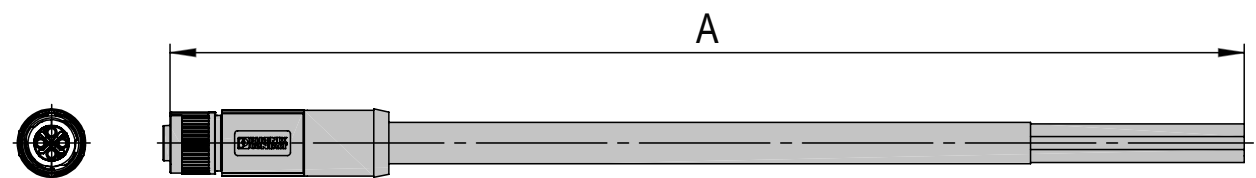

Motor cable-M27-90	5m-90-open-1	10m-90-open-1
<b>Order number</b>	<b>50545335</b>	<b>50545336</b>
Net weight	0.75 kg	1.48 kg
Cable Ø	9.7 mm	9.7 mm
Min. bending radii	97 mm	97 mm
Material	PUR	PUR
A	5 m	10 m

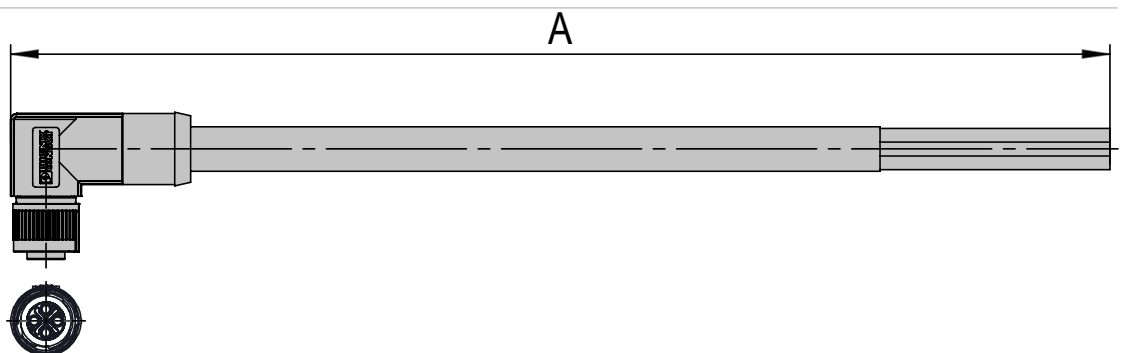

# Encoder cables

## Adapter ES8/12 cable M16

<b>Order number</b>	<b>50455642</b>
Net weight	0.1 kg
Cable Ø	11.2 mm
Min. bending radii	static 50
Material	PUR
A	0.11 m

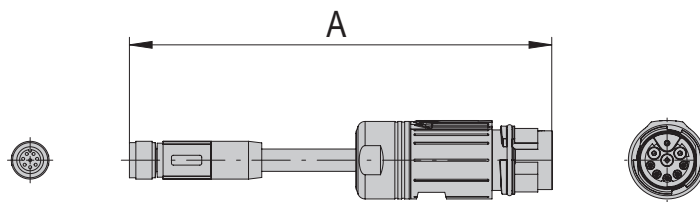

## Encoder cable-G5

5m-0-0-1

10m-0-0-1

<b>Order number</b>	<b>50075695</b>	<b>50224183</b>
Net weight	0.4 kg	0.7 kg
Cable Ø	7 mm	7 mm
Min. bending radii	90 mm	90 mm
Material	PUR	PUR
A	5 m	10 m

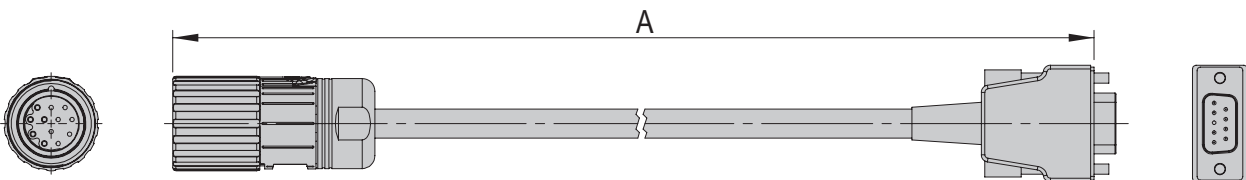

## Encoder cable-G6

5m-0-0-1

10m-0-0-1

<b>Order number</b>	<b>50100693</b>	<b>50224185</b>
Net weight	0.2 kg	0.4 kg
Cable Ø	7 mm	7 mm
Min. bending radii	90 mm	90 mm
Material	PUR	PUR
A	5 m	10 m

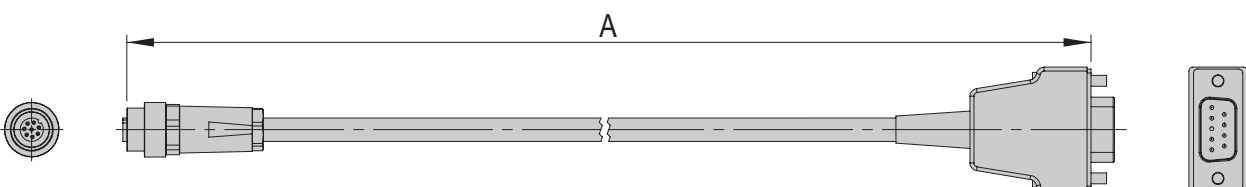

# Encoder cables

Encoder cable-G10	5m-0-0-1	10m-0-0-1
<b>Order number</b>	<b>50297199</b>	<b>50310508</b>
Net weight	0.6 kg	1.2 kg
Cable Ø	9.2 mm	9.2 mm
Min. bending radii	90 mm	90 mm
Material	PUR	PUR
A	5 m	10 m

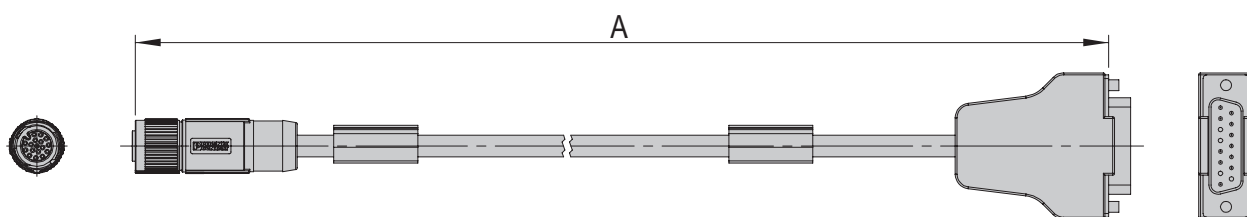

10

Encoder cable-G10-90	5m-90-0-1	10m-90-0-1
<b>Order number</b>	<b>50297200</b>	<b>50310509</b>
Net weight	0.6 kg	1.1 kg
Cable Ø	9.2 mm	9.2 mm
Min. bending radii	90 mm	90 mm
Material	PUR	PUR
A	5 m	10 m

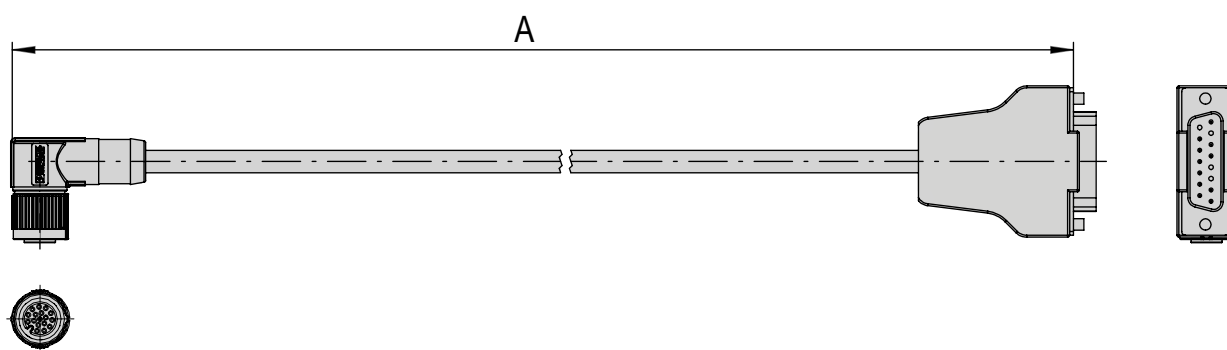

# Encoder cables

Encoder cable-G11	5m-0-0-1	10m-0-0-1
<b>Order number</b>	<b>50311323</b>	<b>50311325</b>
Net weight	0.6 kg	1.2 kg
Cable Ø	8.5 mm	8.5 mm
Min. bending radii	90 mm	90 mm
Material	PUR	PUR
A	5 m	10 m

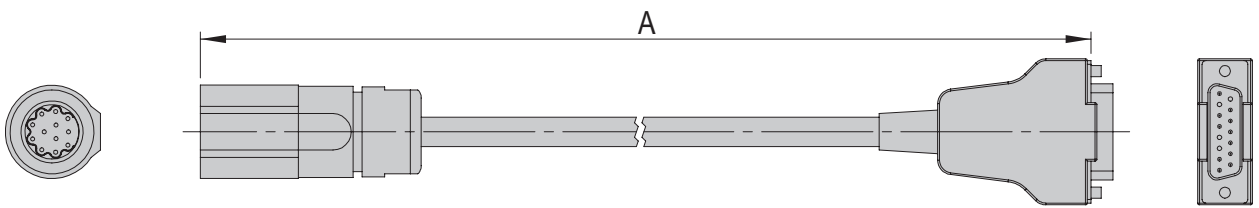

Encoder cable-G12	3m-0-0-1	5m-0-0-1
<b>Order number</b>	<b>50332416</b>	<b>50338975</b>
Net weight	0.4 kg	0.6 kg
Cable Ø	9.2 mm	9.2 mm
Min. bending radii	90 mm	90 mm
Material	PUR	PUR
A	3 m	5 m

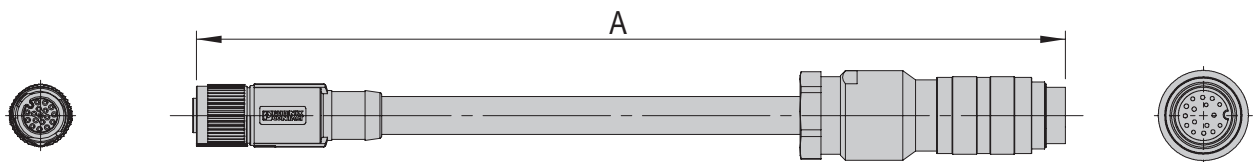

Encoder cable-G12-90	3m-90-0-1	5m-90-0-1
<b>Order number</b>	<b>50332417</b>	<b>50338976</b>
Net weight	0.4 kg	0.6 kg
Cable Ø	9.2 mm	9.2 mm
Min. bending radii	90 mm	90 mm
Material	PUR	PUR
A	3 m	5 m

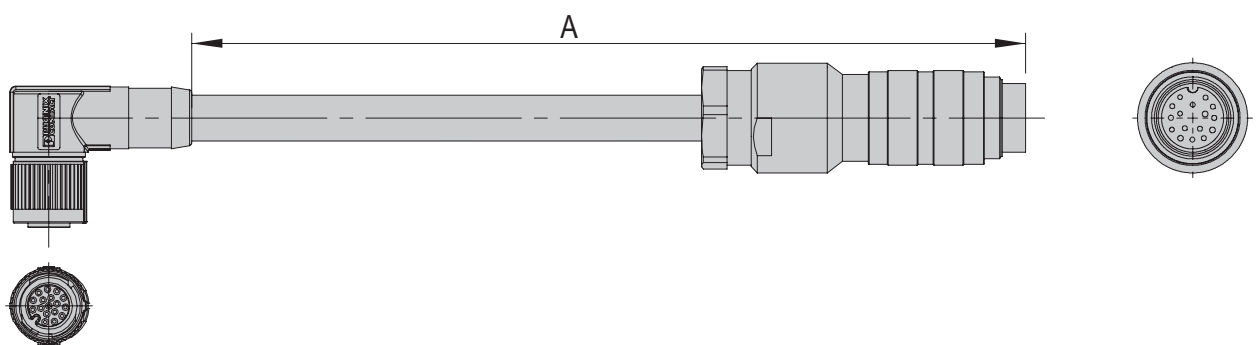

# Encoder cables

Encoder cable-G14	3m-0-0-1	5m-0-0-1	10m-0-0-1
<b>Order number</b>	<b>50443145</b>	<b>50439300</b>	<b>50450518</b>
Net weight	0.2 kg	0.3 kg	0.6 kg
A	3 m	5 m	10 m

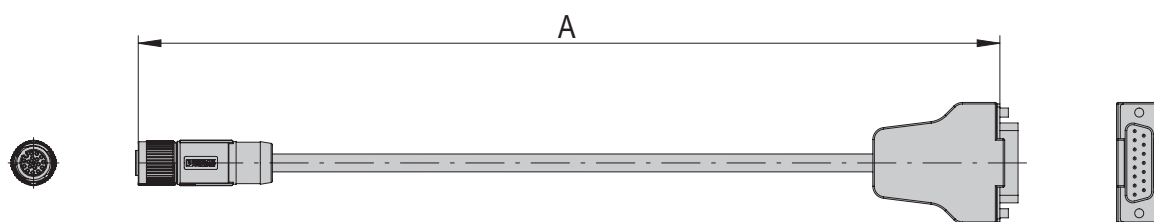

10

Encoder cable-G14-90	3m-90-0-1	5m-90-0-1	10m-90-0-1
<b>Order number</b>	<b>50450519</b>	<b>50450520</b>	<b>50450521</b>
Net weight	0.1 kg	0.2 kg	0.4 kg
A	3 m	5 m	10 m

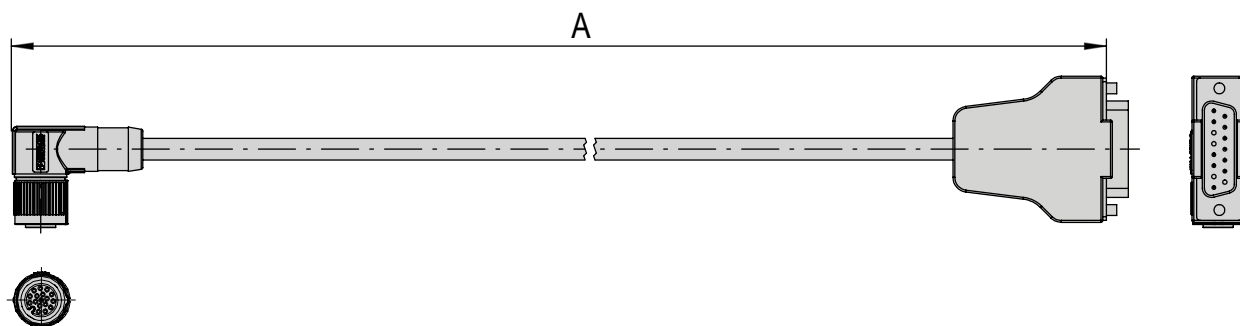

Encoder cable-G16	5m-0-0-1	10m-0-0-1
<b>Order number</b>	<b>50450376</b>	<b>50446252</b>
Net weight	0.4 kg	0.8 kg
A	5 m	10 m

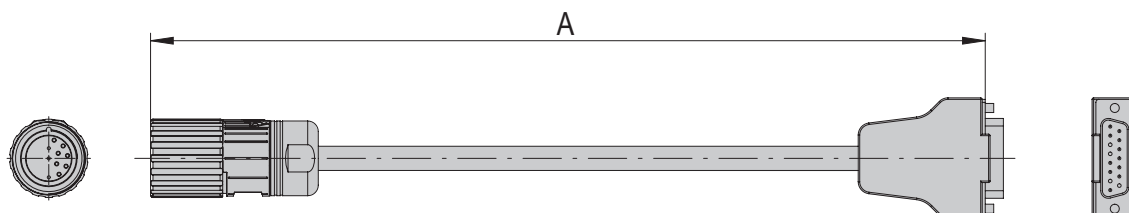



# Encoder cables

Encoder cable-G17	5m-0-0-1	10m-0-0-1
<b>Order number</b>	<b>50450378</b>	<b>50450379</b>
Net weight	0.4 kg	0.8 kg
A	5 m	10 m

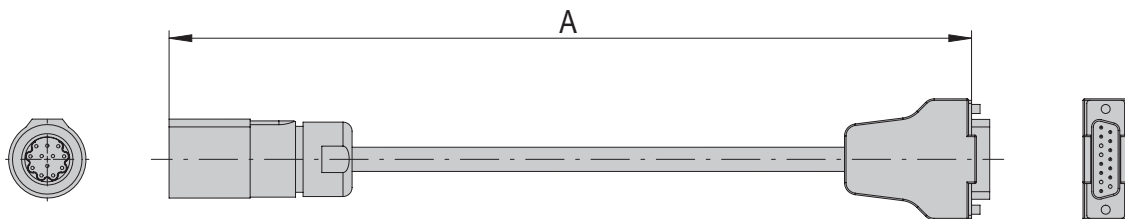

Encoder cable-G18	10m-0-0-1
<b>Order number</b>	<b>50468310</b>
Net weight	0.6 kg
A	10 m

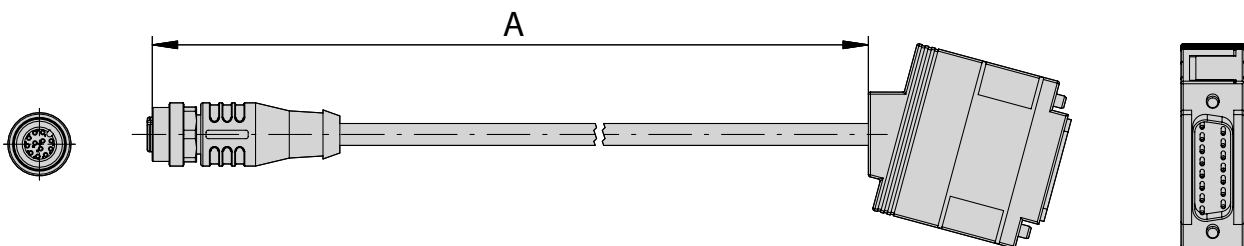

Encoder cable-G18-90	10m-90-0-1
<b>Order number</b>	<b>50468311</b>
Net weight	0.6 kg
A	10 m

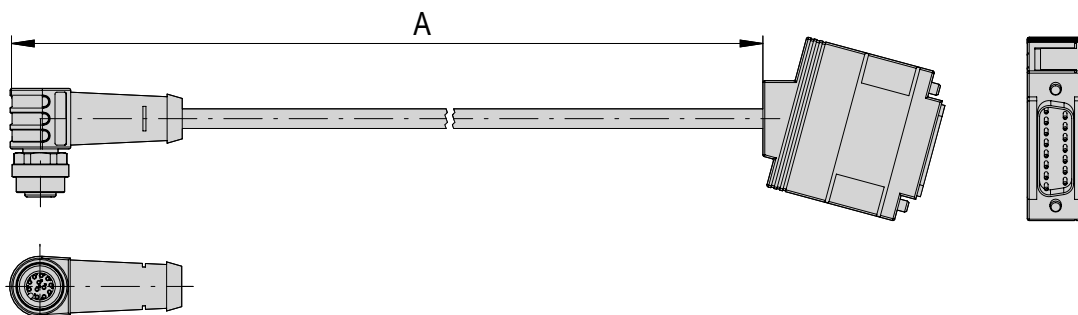

# Encoder cables

Extension-G18	2m-0-0-1
<b>Order number</b>	<b>50468312</b>
Net weight	0.1 kg
A	2 m

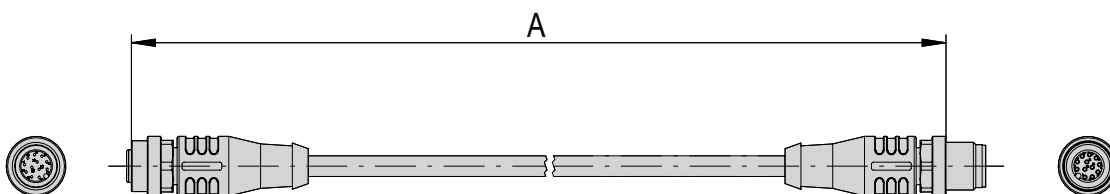

Extension-G18	5m-0-0-1
<b>Order number</b>	<b>50468313</b>
Net weight	0.3 kg
A	5 m

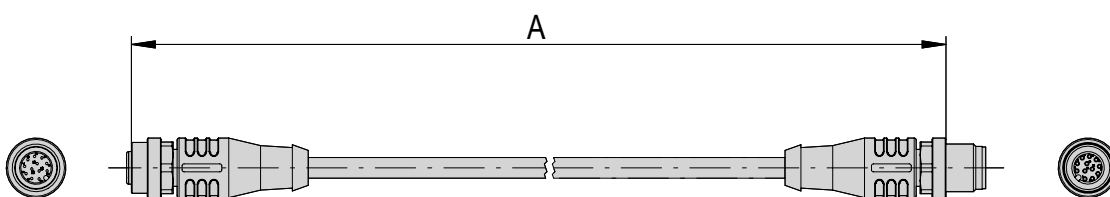

Encoder cable-G19	10m-0-0-1
<b>Order number</b>	<b>50468314</b>
Net weight	0.6 kg
A	10 m

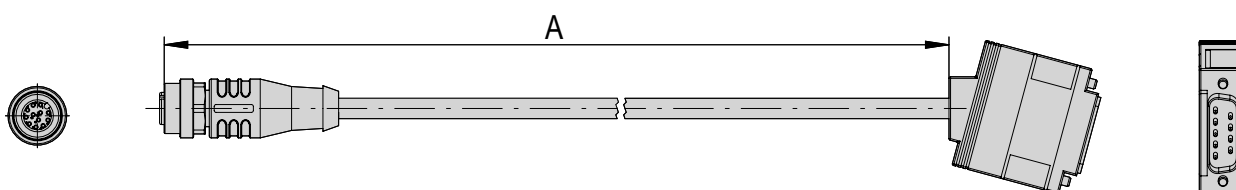

Encoder cable-G19-90	10m-0-0-1
<b>Order number</b>	<b>50468315</b>
Net weight	0.6 kg
A	10 m

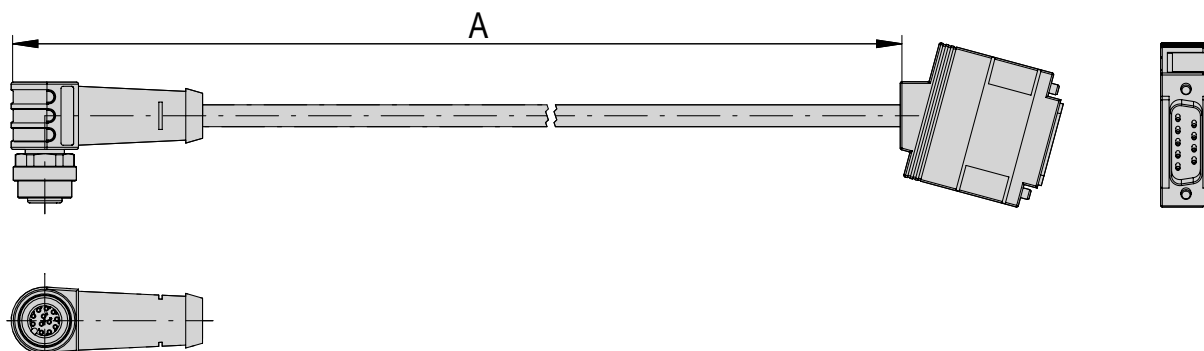

# Proximity switch cables

Proximity switch cable-R1	2m-0-open	3m-0-open	5m-0-open	10m-0-open
<b>Order number</b>	<b>11006443</b>	<b>50340925</b>	<b>11006446</b>	<b>50072072</b>
Net weight	0.03 kg	0.03 kg	0.1 kg	0.2 kg
Cable Ø	4.5 mm	4.5 mm	4.5 mm	4.5 mm
Min. bending radii	50 mm	50 mm	50 mm	50 mm
Material	PUR	PUR	PUR	PUR
A	2 m	3 m	5 m	10 m

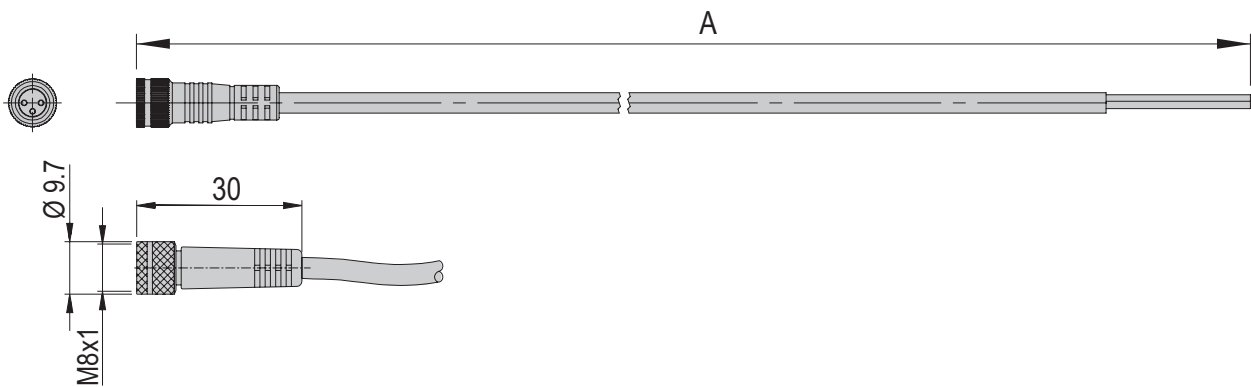

Proximity switch cable-R1-90	2m-90-open	3m-90-open	5m-90-open	10m-90-open
<b>Order number</b>	<b>11006447</b>	<b>50340954</b>	<b>11007826</b>	<b>50310513</b>
Net weight	0.04 kg	0.04 kg	0.1 kg	0.2 kg
Cable Ø	4.5 mm	4.5 mm	4.5 mm	4.5 mm
Min. bending radii	50 mm	50 mm	50 mm	50 mm
Material	PUR	PUR	PUR	PUR
A	2 m	3 m	5 m	10 m

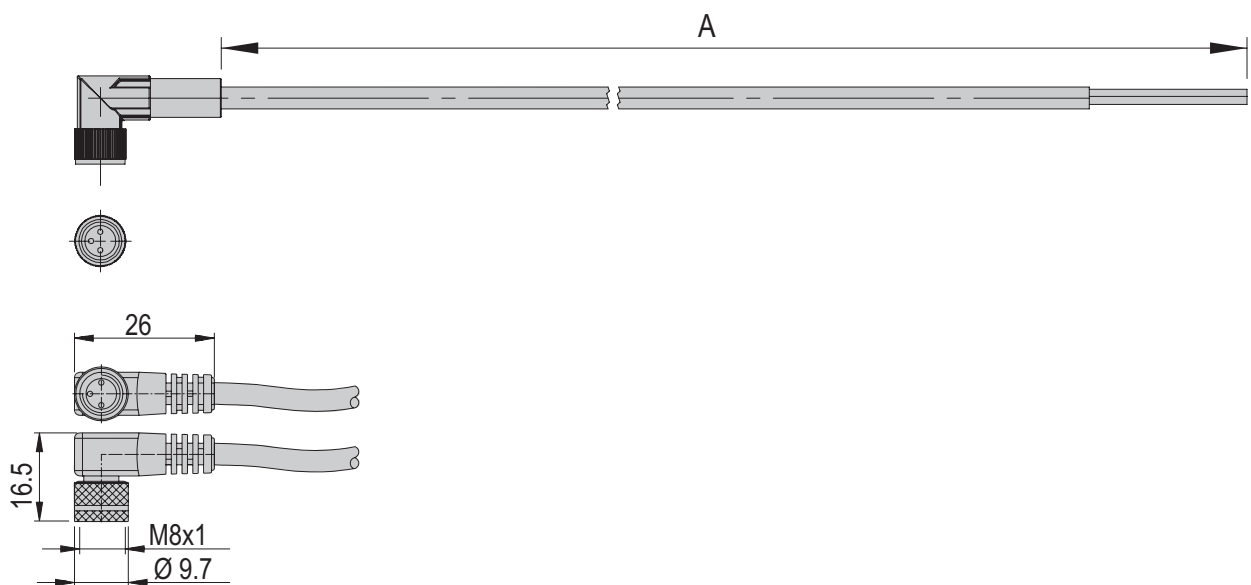

# Proximity switch cables

Proximity switch cable-R2	0.6m-0-0	3m-0-0	5m-0-0
<b>Order number</b>	<b>11015003</b>	<b>50340271</b>	<b>11017754</b>
Net weight	0.04 kg	0.07 kg	0.1 kg
Cable Ø	4.5 mm	4.5 mm	4.5 mm
Min. bending radii	50 mm	50 mm	50 mm
Material	PUR	PUR	PUR
A	0.6 m	3 m	5 m

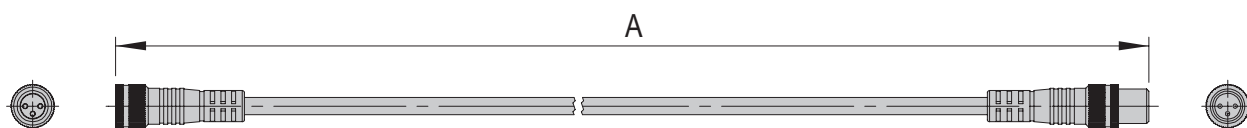

10

Proximity switch cable-R2-90	3m-90-0	5m-90-0
<b>Order number</b>	<b>50340272</b>	<b>50340903</b>
Net weight	0.08 kg	0.1 kg
Cable Ø	4.5 mm	4.5 mm
Min. bending radii	50 mm	50 mm
Material	PUR	PUR
A	3 m	5 m

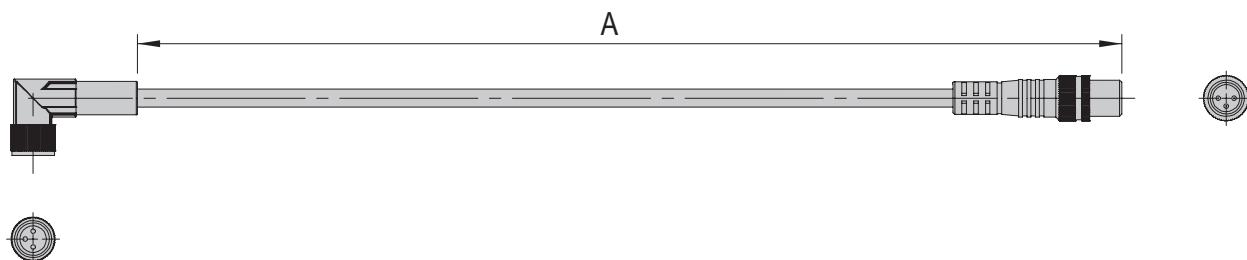

Proximity switch cable-R3	2m-0-open	5m-0-open	10m-0-open
<b>Order number</b>	<b>11006428</b>	<b>11006431</b>	<b>50098553</b>
Net weight	0.03 kg	0.1 kg	0.2 kg
Cable Ø	4.5 mm	4.5 mm	4.5 mm
Min. bending radii	50 mm	50 mm	50 mm
Material	PVC	PVC	PVC
A	2 m	5 m	10 m

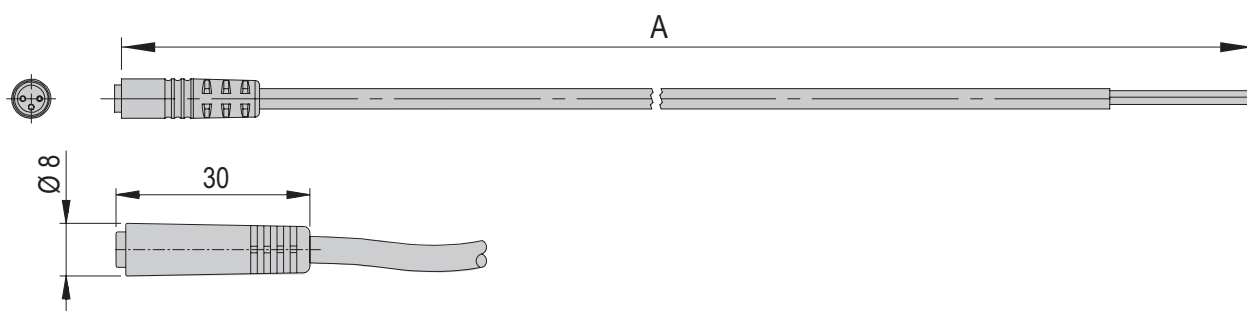

# Proximity switch cables

Proximity switch cable-R3-90	2m-90-open	5m-90-open
<b>Order number</b>	<b>11006429</b>	<b>11006430</b>
Net weight	0.03 kg	0.1 kg
Cable Ø	4.5 mm	4.5 mm
Min. bending radii	50 mm	50 mm
Material	PVC	PVC
A	2 m	5 m

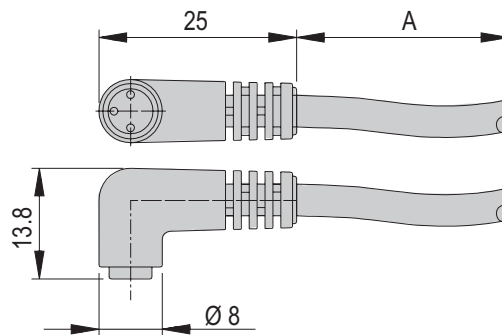

Proximity switch cable-R6	1.5m-0-0
<b>Order number</b>	<b>50164838</b>
Net weight	0.07 kg
Cable Ø	4.5 mm
Min. bending radii	50 mm
Material	PUR

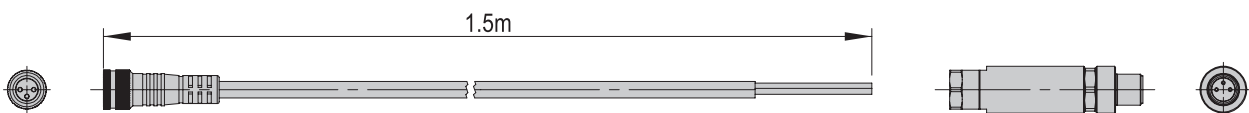

Proximity switch cable-R8	3m-0-open	5m-0-open	10n-0-open
<b>Order number</b>	<b>50340912</b>	<b>50265807</b>	<b>50310514</b>
Net weight	0.04 kg	0.07 kg	0.1 kg
Cable Ø	4.5 mm	4.5 mm	4.5 mm
Min. bending radii	50 mm	50 mm	50 mm
Material	PUR	PUR	PUR
A	3 m	5 m	10 m

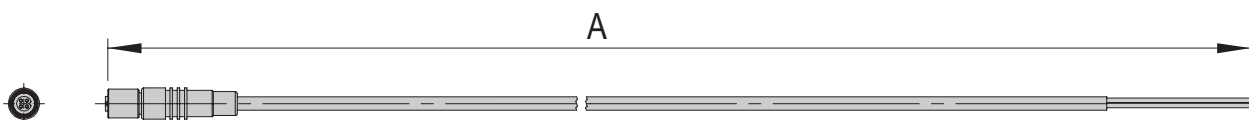

## Proximity switch cables

Proximity switch cable-R10		0.1m-0-00
<b>Order number</b>		<b>50386489</b>
Net weight		0.05 kg
Cable Ø		3 mm
Min. bending radii		50 mm
Material		PUR
A		0.1 m

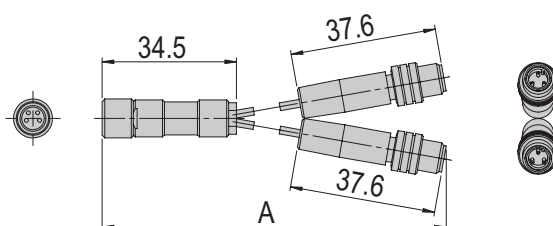

10

Converter PNP/NPN		50113272
<b>Order number</b>		<b>50113272</b>
Net weight		0.01 kg
Cable Ø		4 mm

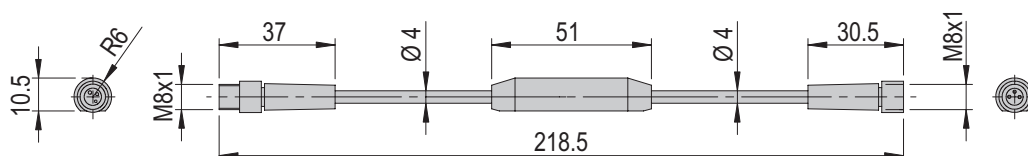

## Power cables

Power cable SE-24		
<b>Order number</b>	<b>50118124</b>	<b>50235739</b>
Net weight	1.1 kg	0.3 kg
Cable Ø	11.3 mm	11.3 mm
Material	PVC	PVC
A	5 m	10 m

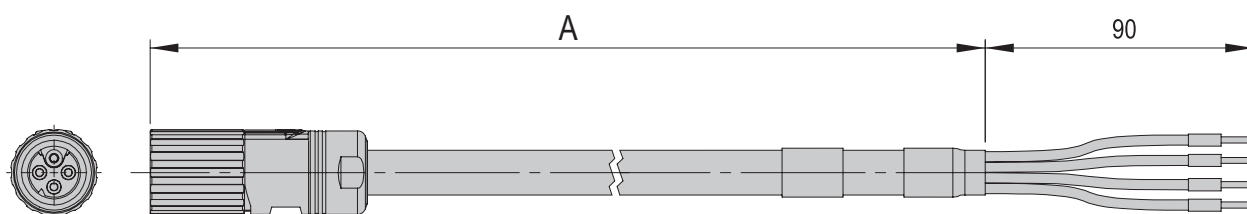

## I/O cables

I/O cable SE-24		
Order number	50312913	50342940
Net weight	0.03 kg	0.06 kg
Cable Ø	6 mm	6 mm
Material	PVC	PVC
A	5 m	10 m

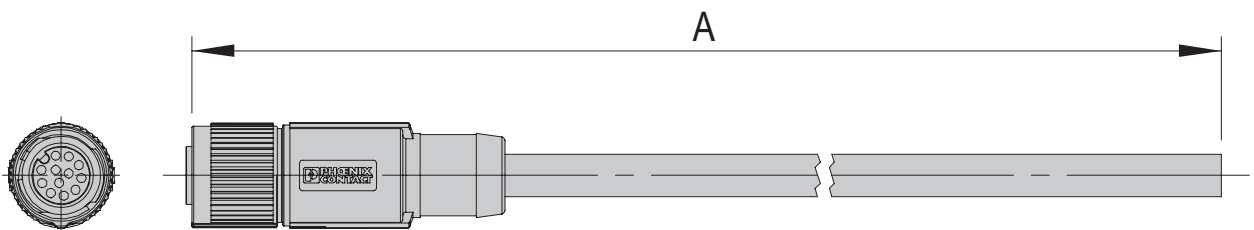

## Sensor-actuator cables

Sensor-actuator cable-S1		0.6m-0-open-1
Order number	50512492	
Net weight	0.04 kg	
Cable Ø	5 mm	
Material	PUR	
A	0.6 m	



# Sensor-actuator cables

Sensor-actuator cable-S2		5m-0-open-1
<b>Order number</b>		<b>50512467</b>
Net weight		0.20 kg
Cable Ø		5 mm
Material		PUR
A		5 m

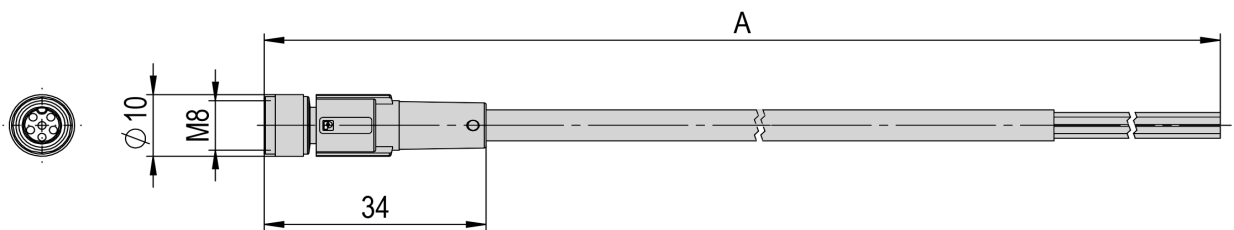

Sensor-actuator cable-S3		2m-0-open-1	5m-0-open-1
<b>Order number</b>		<b>50359710</b>	<b>11007828</b>
Net weight		0.01 kg	0.01 kg
Cable Ø		5 mm	5 mm
Material		PUR	PUR
A		2 m	5 m

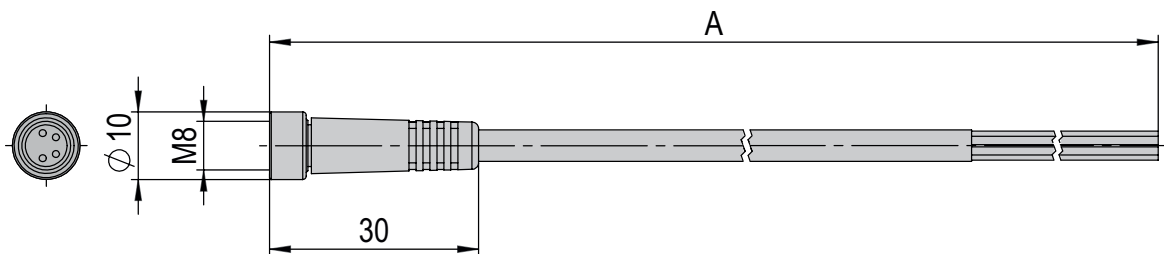

Sensor-actuator cable-S3		2m-90-open-1	5m-90-open-1
<b>Order number</b>		<b>50551477</b>	<b>50551478</b>
Net weight		0.01 kg	0.01 kg
Cable Ø		5 mm	5 mm
Material		PUR	PUR
A		2 m	5 m

