

# Proximity switches

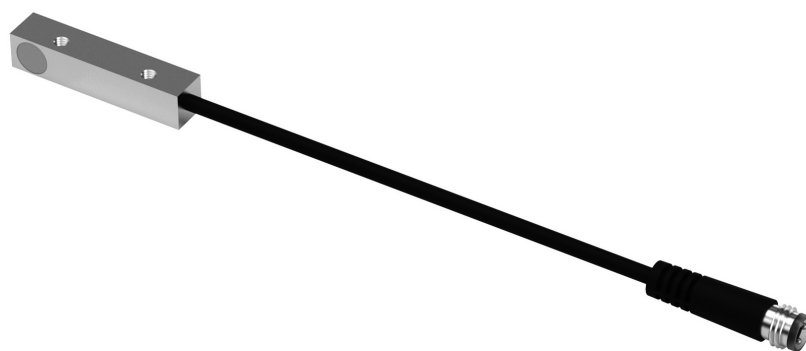

# Table of contents: Proximity switches

| <b>Proximity switches</b>      | <b>Page</b> |
|--------------------------------|-------------|
| Proximity switches             | 72          |
| Accessories proximity switches | 76          |

|                                   | 50448226 | 50001023 | 11009034 | 50448225 | 50093507 | 11016714 | 11010759 | 50003811 | 11005439 | 50230625 | 50428013 | 50144770 | 50313987 | 50536020 | 50033432 | 11012933 | 50562677 |
|-----------------------------------|----------|----------|----------|----------|----------|----------|----------|----------|----------|----------|----------|----------|----------|----------|----------|----------|----------|
| INI d3x12-Sn0.8-PNP-NO            |          |          |          |          |          |          |          |          |          |          |          |          |          |          |          |          |          |
| INI d3x22-Sn0.8-PNP-NO-M8x1       |          |          |          |          |          |          |          |          |          |          |          |          |          |          |          |          |          |
| INI d4/6.5x45-Sn1.0-PNP-NO-M8x1   |          |          |          |          |          |          |          |          |          |          |          |          |          |          |          |          |          |
| INI M4x12-Sn0.8-PNP-NO            |          |          |          |          |          |          |          |          |          |          |          |          |          |          |          |          |          |
| INI d4x2.5-Sn1.0-PNP-NC-M8x1      |          |          |          |          |          |          |          |          |          |          |          |          |          |          |          |          |          |
| INI d4x2.5-Sn1.0-PNP-NO-M8x1      |          |          |          |          |          |          |          |          |          |          |          |          |          |          |          |          |          |
| INI 6.3x4.7x26.3-Em-PNP-NO-M8x1   |          |          |          |          |          |          |          |          |          |          |          |          |          |          |          |          |          |
| INI d6.5x35-Sn1.5-PNP-NO-M8x1     |          |          |          |          |          |          |          |          |          |          |          |          |          |          |          |          |          |
| INI d6.5x44-Sn1.5-PNP-NO-M8x1     |          |          |          |          |          |          |          |          |          |          |          |          |          |          |          |          |          |
| INI 8x4.7x16-Sn2.0-PNP-NC-M8x1    |          |          |          |          |          |          |          |          |          |          |          |          |          |          |          |          |          |
| INI 8x8x38.5-Sn1.5-PNP-NO-M8x1    |          |          |          |          |          |          |          |          |          |          |          |          |          |          |          |          |          |
| INI d8x36-Sn2.0-PNP-NC-M8x1       |          |          |          |          |          |          |          |          |          |          |          |          |          |          |          |          |          |
| INI c10x19.5-Em-PNP-NO-M8x1       |          |          |          |          |          |          |          |          |          |          |          |          |          |          |          |          |          |
| INI c10x19.5-Em-PNP-NO-M8x1 black |          |          |          |          |          |          |          |          |          |          |          |          |          |          |          |          |          |
| INI c10x28.5-Em-PNP-NO-M8x1       |          |          |          |          |          |          |          |          |          |          |          |          |          |          |          |          |          |
| INI 10.5x5.8x30-Em-PNP-NO-M8x1    |          |          |          |          |          |          |          |          |          |          |          |          |          |          |          |          |          |
| INI c10x20-Em-PNP-NO-M8x1         |          |          |          |          |          |          |          |          |          |          |          |          |          |          |          |          |          |
| CS 6                              |          |          |          |          |          |          |          |          |          |          |          |          |          |          |          |          |          |
| CS 8                              |          |          |          |          |          |          |          |          |          |          |          |          |          |          |          |          |          |
| CS 12                             |          |          |          |          |          |          |          |          |          |          |          |          |          |          |          |          |          |
| CS 16                             |          |          |          |          |          |          |          |          |          |          |          |          |          |          |          |          |          |
| ZA-CS 16                          |          |          |          |          |          |          |          |          |          |          |          |          |          |          |          |          |          |
| CS 20                             |          |          |          |          |          |          |          |          |          |          |          |          |          |          |          |          |          |
| ZA-CS 20                          |          |          |          |          |          |          |          |          |          |          |          |          |          |          |          |          |          |
| CS 25                             |          |          |          |          |          |          |          |          |          |          |          |          |          |          |          |          |          |
| ZA-CS 25                          |          |          |          |          |          |          |          |          |          |          |          |          |          |          |          |          |          |
| LM 12                             |          |          |          |          |          |          |          |          |          |          |          |          |          |          |          |          |          |
| PS 16                             |          |          |          |          |          |          |          |          |          |          |          |          |          |          |          |          |          |
| PS 25                             |          |          |          |          |          |          |          |          |          |          |          |          |          |          |          |          |          |
| PS 32                             |          |          |          |          |          |          |          |          |          |          |          |          |          |          |          |          |          |
| LM 16                             |          |          |          |          |          |          |          |          |          |          |          |          |          |          |          |          |          |
| LM 20                             |          |          |          |          |          |          |          |          |          |          |          |          |          |          |          |          |          |
| LM 25                             |          |          |          |          |          |          |          |          |          |          |          |          |          |          |          |          |          |
| ZA 20/25                          |          |          |          |          |          |          |          |          |          |          |          |          |          |          |          |          |          |
| LM 32                             |          |          |          |          |          |          |          |          |          |          |          |          |          |          |          |          |          |
| ZA 32                             |          |          |          |          |          |          |          |          |          |          |          |          |          |          |          |          |          |
| ZA-PS                             |          |          |          |          |          |          |          |          |          |          |          |          |          |          |          |          |          |
| HM 10                             |          |          |          |          |          |          |          |          |          |          |          |          |          |          |          |          |          |
| HM 16                             |          |          |          |          |          |          |          |          |          |          |          |          |          |          |          |          |          |
| HM 25                             |          |          |          |          |          |          |          |          |          |          |          |          |          |          |          |          |          |
| PMP                               |          |          |          |          |          |          |          |          |          |          |          |          |          |          |          |          |          |
| ZA-PMP                            |          |          |          |          |          |          |          |          |          |          |          |          |          |          |          |          |          |
| PMP-c                             |          |          |          |          |          |          |          |          |          |          |          |          |          |          |          |          |          |
| OZ-50                             |          |          |          |          |          |          |          |          |          |          |          |          |          |          |          |          |          |
| OZ-60                             |          |          |          |          |          |          |          |          |          |          |          |          |          |          |          |          |          |
| PEZ-52                            |          |          |          |          |          |          |          |          |          |          |          |          |          |          |          |          |          |
| PEZ-65                            |          |          |          |          |          |          |          |          |          |          |          |          |          |          |          |          |          |
| PEZ-80                            |          |          |          |          |          |          |          |          |          |          |          |          |          |          |          |          |          |
| PEZ-100                           |          |          |          |          |          |          |          |          |          |          |          |          |          |          |          |          |          |
| PDZ-128                           |          |          |          |          |          |          |          |          |          |          |          |          |          |          |          |          |          |
| PDZ-160                           |          |          |          |          |          |          |          |          |          |          |          |          |          |          |          |          |          |
| PDZ-200                           |          |          |          |          |          |          |          |          |          |          |          |          |          |          |          |          |          |
| CR 12                             |          |          |          |          |          |          |          |          |          |          |          |          |          |          |          |          |          |
| CR 16                             |          |          |          |          |          |          |          |          |          |          |          |          |          |          |          |          |          |
| CR 20                             |          |          |          |          |          |          |          |          |          |          |          |          |          |          |          |          |          |
| CR 25                             |          |          |          |          |          |          |          |          |          |          |          |          |          |          |          |          |          |
| CR 32                             |          |          |          |          |          |          |          |          |          |          |          |          |          |          |          |          |          |
| RM 12                             |          |          |          |          |          |          |          |          |          |          |          |          |          |          |          |          |          |
| RMZ 12                            |          |          |          |          |          |          |          |          |          |          |          |          |          |          |          |          |          |
| RM 16                             |          |          |          |          |          |          |          |          |          |          |          |          |          |          |          |          |          |
| RM 25                             |          |          |          |          |          |          |          |          |          |          |          |          |          |          |          |          |          |
| RM 32                             |          |          |          |          |          |          |          |          |          |          |          |          |          |          |          |          |          |
| RM 63                             |          |          |          |          |          |          |          |          |          |          |          |          |          |          |          |          |          |
| PG 12                             |          |          |          |          |          |          |          |          |          |          |          |          |          |          |          |          |          |
| PG 16                             |          |          |          |          |          |          |          |          |          |          |          |          |          |          |          |          |          |
| PG 20                             |          |          |          |          |          |          |          |          |          |          |          |          |          |          |          |          |          |
| UG 20                             |          |          |          |          |          |          |          |          |          |          |          |          |          |          |          |          |          |
| UG 25                             |          |          |          |          |          |          |          |          |          |          |          |          |          |          |          |          |          |
| GMQ 12                            |          |          |          |          |          |          |          |          |          |          |          |          |          |          |          |          |          |
| GMQ 20                            |          |          |          |          |          |          |          |          |          |          |          |          |          |          |          |          |          |
| GMQ 32                            |          |          |          |          |          |          |          |          |          |          |          |          |          |          |          |          |          |
| DG 16                             |          |          |          |          |          |          |          |          |          |          |          |          |          |          |          |          |          |
| DG 20                             |          |          |          |          |          |          |          |          |          |          |          |          |          |          |          |          |          |

**Standard**  
**Alternative**  
**Proximity switches nomenclature**  
 INI: Proximity switch  
 c: C-slot  
 d: Diameter  
 Em: Electromagnetic  
 Sn: Switching distance  
 PNP: PNP  
 NO: Normally open  
 NC: Normally close  
 M8x1: Connection thread

# Proximity switches

## INI d3x12-Sn0.8-PNP-NO

**Order number** 50448226

Net weight 0.01 kg

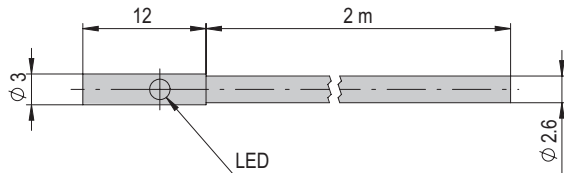

## INI d3x22-Sn0.8-PNP-NO-M8x1

**Order number** 50001023

Net weight 0.005 kg

Operating voltage 10 - 30 VDC

Switching distance 0.8 mm

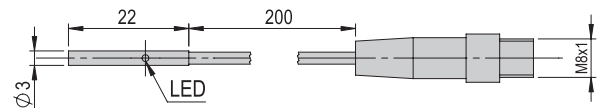

## INI d4/6.5x45-Sn1.0-PNP-NO-M8x1

**Order number** 11009034

Net weight 0.008 kg

Operating voltage 10 - 30 VDC

Switching distance 0.8 mm

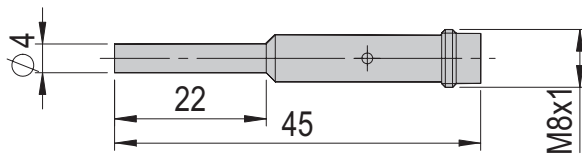

## INI d4x25-Sn1.0-PNP-NC-M8x1

**Order number** 50093507

Net weight 0.004 kg

Operating voltage 10 - 30 VDC

Switching distance 1.0 mm

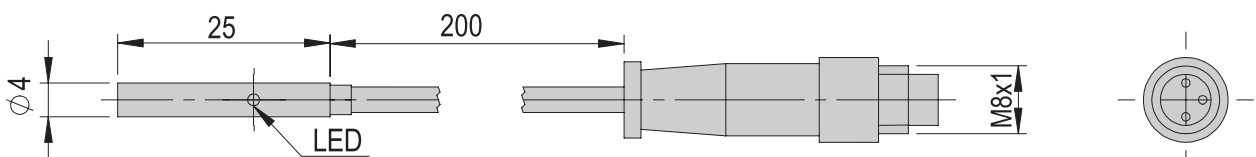

## INI d4x25-Sn1.0-PNP-NO-M8x1

**Order number** 11016714

Net weight 0.002 kg

Operating voltage 10 - 30 VDC

Switching distance 1.0 mm

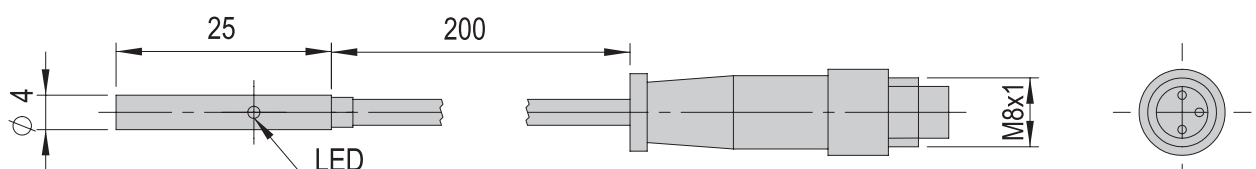

**INI M4x12-Sn0.8-PNP-NO**

**Order number** 50448225

Net weight 0.01 kg

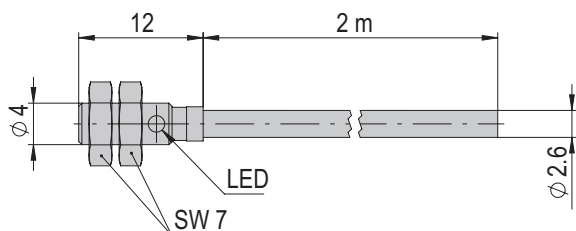

**INI d5x36-Sn2.0-PNP-NC-M8x1**

**Order number** 50285525

Net weight 0.007 kg

Operating voltage 10 - 30 VDC

Switching distance 1.5 mm

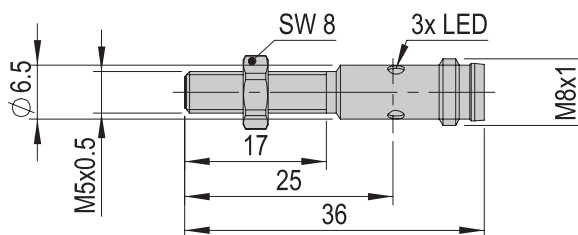

**INI 6.3x4.7x26.3-Em-PNP-NO-M8x1**

**Order number** 11010759

Net weight 0.007 kg

Operating voltage 10 - 30 VDC

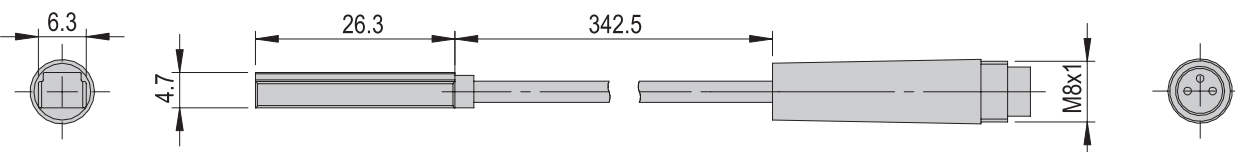

**INI d6.5x35-Sn1.5-PNP-NO-M8x1**

**Order number** 50003811

Net weight 0.009 kg

Operating voltage 10 - 30 VDC

Switching distance 1.5 mm

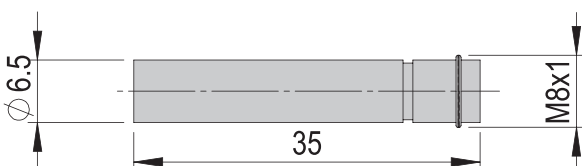

**INI d6.5x44-Sn1.5-PNP-NO-M8x1**

**Order number** 11005439

Net weight 0.005 kg

Operating voltage 10 - 30 VDC

Switching distance 1.5 mm

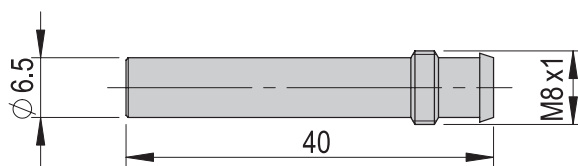

**INI 8x4.7x16-Sn2.0-PNP-NC-M8x1**

**Order number** 50230625

Net weight 0.004 kg

Operating voltage 10 - 30 VDC

Switching distance 1.5 mm

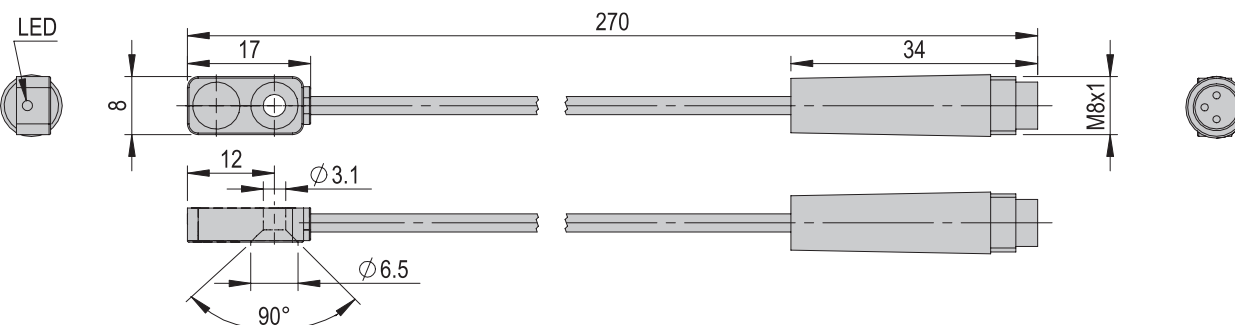

INI 8x8x38.5-Sn1.5-PNP-NO-M8x1

|                     |                 |
|---------------------|-----------------|
| <b>Order number</b> | <b>50428013</b> |
| Net weight          | 0.043           |
| Operating voltage   | 10 - 30 VDC     |
| Switching distance  | 1.5 mm          |

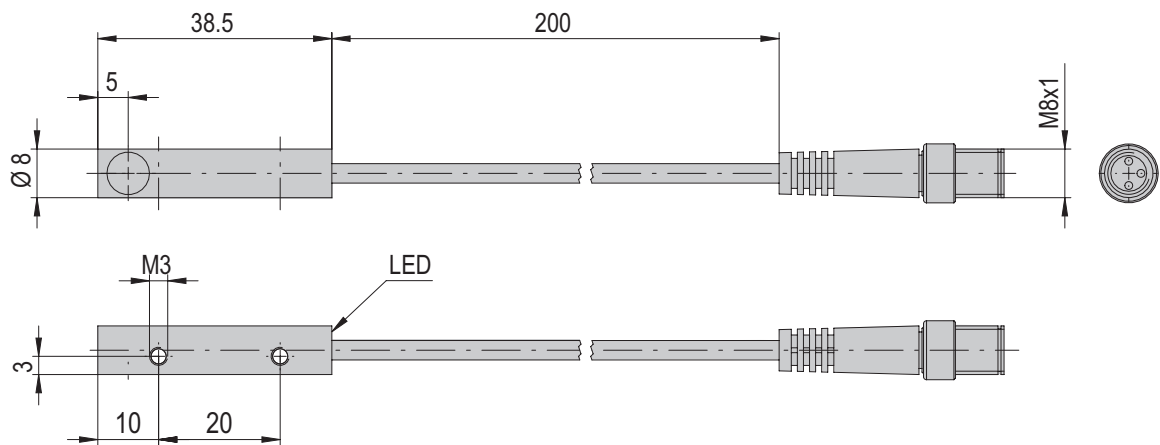

6

INI d8x36-Sn2.0-PNP-NC-M8x1

|                     |                 |
|---------------------|-----------------|
| <b>Order number</b> | <b>50144770</b> |
| Net weight          | 0.014 kg        |
| Operating voltage   | 10 - 30 VDC     |
| Switching distance  | 1.5 mm          |

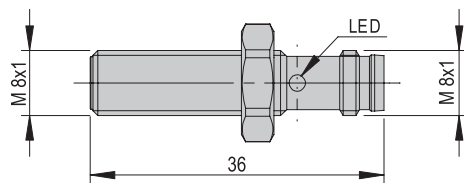

INI c10x19.5-Em-PNP-NO-M8x1

|                     |                 |
|---------------------|-----------------|
| <b>Order number</b> | <b>50313987</b> |
| Net weight          | 0.021 kg        |
| Operating voltage   | 10 - 30 VDC     |

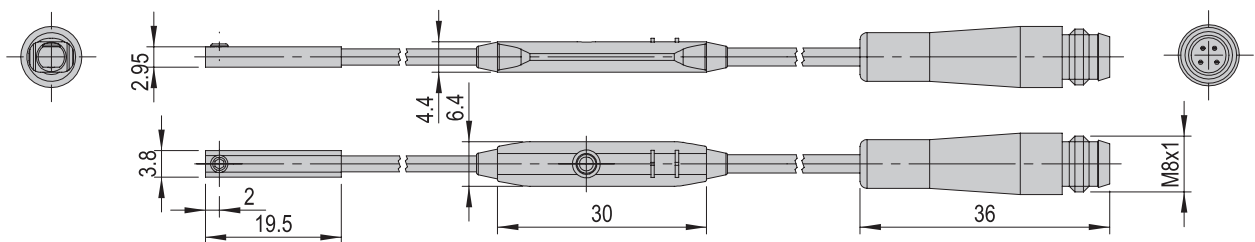

INI c10x28.5-Em-PNP-NO-M8x1

|                     |                 |
|---------------------|-----------------|
| <b>Order number</b> | <b>50033432</b> |
| Net weight          | 0.02 kg         |
| Operating voltage   | 10 - 30 VDC     |

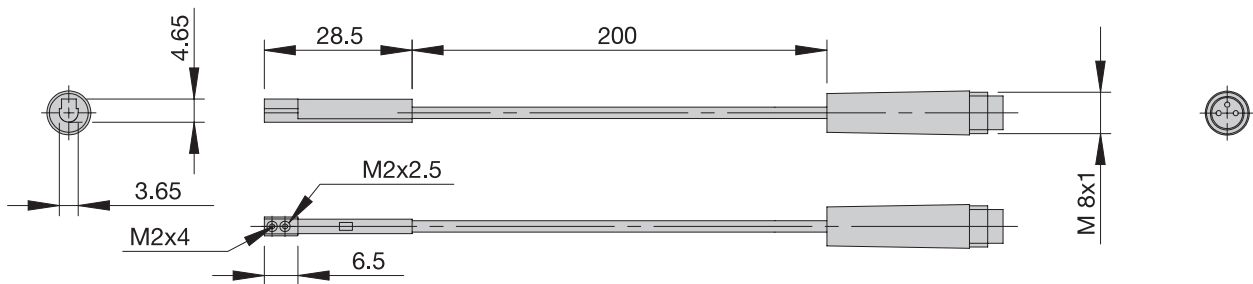

INI 10.5x5.8x30-Em-PNP-NO-M8x1

|                     |                 |
|---------------------|-----------------|
| <b>Order number</b> | <b>11012933</b> |
| Net weight          | 0.013 kg        |
| Operating voltage   | 10 - 30 VDC     |

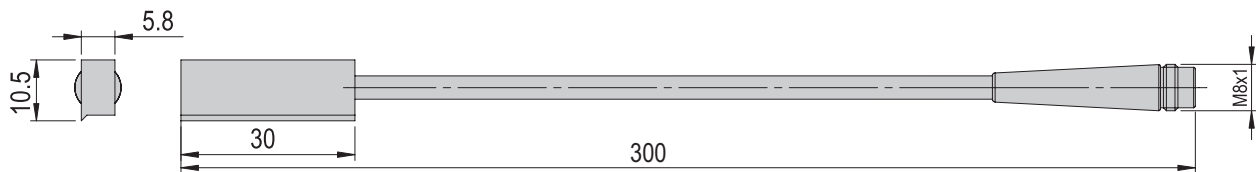

INI c10x19.5-Em-PNP-NO-M8x1-black

|                     |                 |
|---------------------|-----------------|
| <b>Order number</b> | <b>50536020</b> |
| Net weight          | 0.021 kg        |
| Operating voltage   | 10 - 30 VDC     |

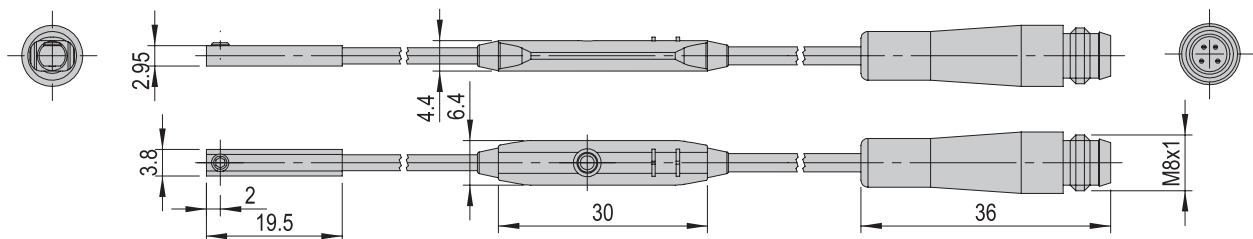

INI c10x20-Em-PNP-NO-M8x1

|                     |                 |
|---------------------|-----------------|
| <b>Order number</b> | <b>50562677</b> |
| Net weight          | 0.021 kg        |
| Operating voltage   | 10 - 30 VDC     |

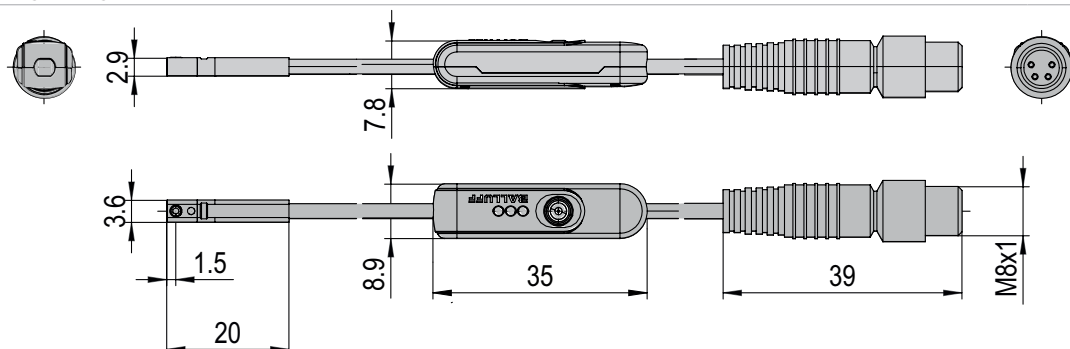

# Accessories proximity switches

## Clamping nut M6x1

**Order number** 50042748

Net weight 0.001 kg

Ø 4 mm

Thread M6 x 1 mm

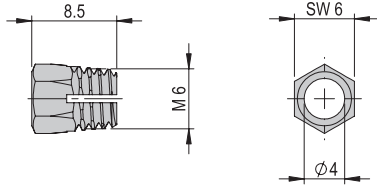

## Clamping nut M8x0.75

**Order number** 11005436

Net weight 0.001 kg

Ø 6.5 mm

Thread M8 x 0.75 mm

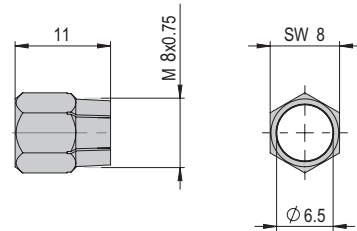

## Proximity switch holder IH9.5/8x8

**Order number** 11004997

Net weight 0.021 kg

Ø 8x8 mm

Material Die-cast zinc

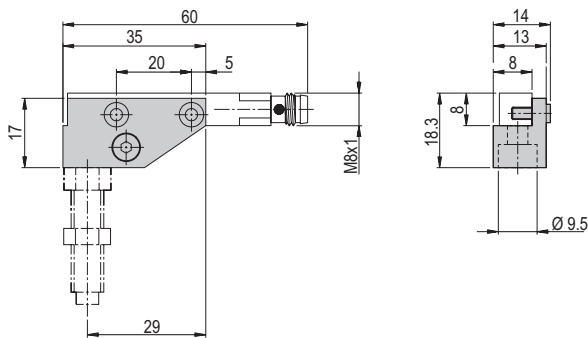

## Proximity switch holder IH10/6.5

**Order number** 11004995

Net weight 0.015 kg

Ø 6.5 mm

Material Brass nickel-plated

