

RNR 181R
HPP-25

Data sheet RNR181R-HPP

Rotary Indexing Table Riveting Machine

Rivet shank Ø: up to 4 mm | Force: up to 3.60 kN | Stroke: up to 30 mm

Key features | Content of delivery

RNR181R-HPP Rotary Indexing Table Riveting Machine

Forming process: Radial

Standard Version

REDUCED FORCE

- RNR181R with HPP-25
- Complete work station; column and riser plate
- Electrical rotary indexing table with 6 stations (optional with 4)
- Safety enclosure
- Two hand start button including safety relay or foot pedal
- With pneumatic ejection of the riveted parts on request
- Standard pneumatics
- Work lamp

- Supply voltage 3x230-280V, 50/60Hz or 3x400/480V, 50/60Hz (other supply voltages on request)
- rivet mushroom & pressure shell Rp=@ mm / Ls=@ mm
- Color: Light grey RAL 7035

Subject to change.

Drawing

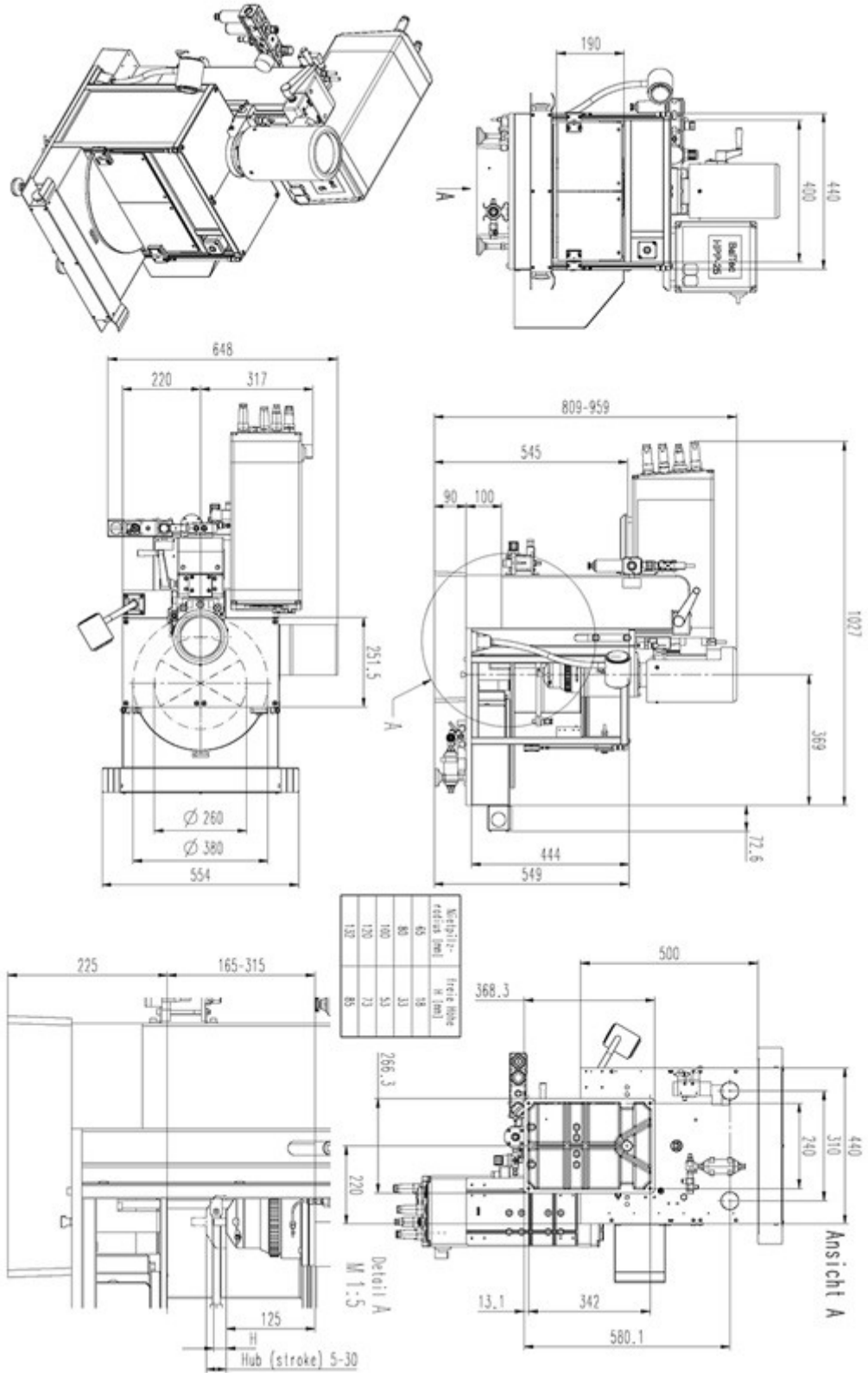

Forming tool lengths

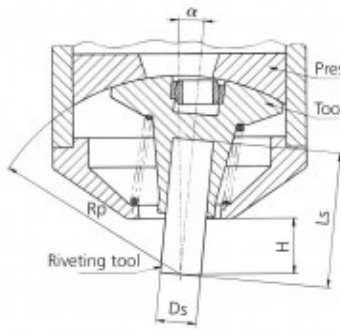

Radius mm Rp	Tool length mm Ls	Free height mm H	Shank Ø mm Ds	Angle of inclination α
65.00	39.00	18.00	10	6° 02'
80.00	54.00	33.00	10	4° 47'
100.00	74.00	53.00	10	3° 44'
120.00	94.00	73.00	10	3° 04'
132.00	106.00	85.00	10	2° 46'

Forming tool profile



Our engineers are routinely meeting the demands of complex design problems. Having the specific tools needed for your metal forming project can mean the difference between success and failure. Contact us with your unique application for custom tooling.

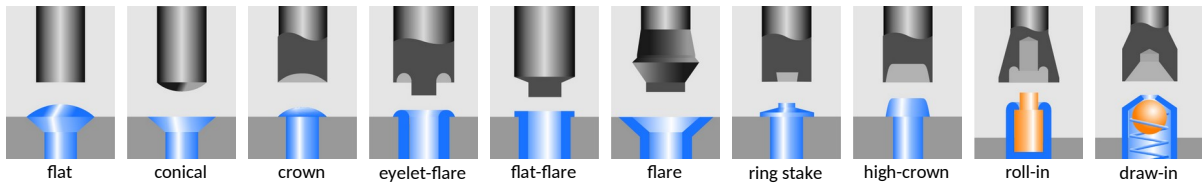

Industries & Applications



BalTec AG
Switzerland / Germany

BalTec (UK) Ltd.
United Kingdom

BalTec France
France

BalTec Corporation
USA / Canada / Mexico

BalTec do Brasil
Brazil

BalTec Machinery (Shanghai) Ltd.
China

BalTec Italia Srl
Italia

BalTec