

RNC 231 RT

Data sheet RNC231-RT87-2030

Coordinate Riveting Machine & Rotary Indexing Table

Rivet shank Ø: up to 8 mm | Force: up to 12.00 kN | Stroke: up to 40 mm

Key features | Content of delivery

RNC231-RT87-2030 Coordinate Riveting Machine & Rotary Indexing Table

Forming process: Radial

- Radial coordinate riveting machine RNC 231 with index table Ø 870 mm
- XY table travel: X= 300, Y=200 mm
- Pneumatic force generation
- Round table in work cell with safety enclosure
- Process monitoring and controlling with process control HPP-25
- 63 riveting programs can be addressed and saved,
- 6 different control parameters / 45 riveting modes
- Integrated logger function, all data are recorded
- Ethernet und USB interfaces
- 5.7" touchscreen LED backlit

Subject to change.

Drawing

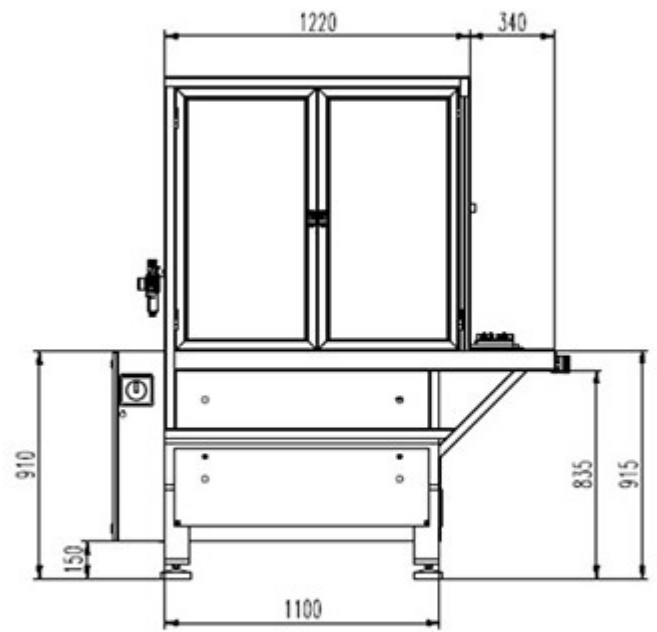
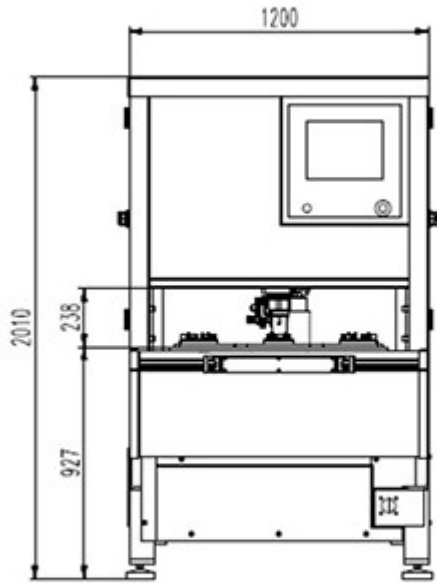

Forming tool lengths

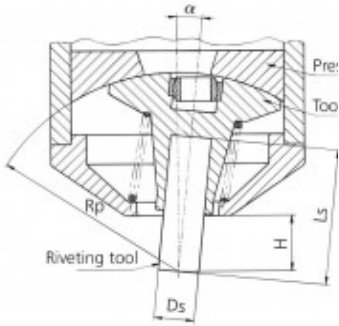

Radius mm Rp	Tool length mm Ls	Free height mm H	Shank Ø mm Ds	Angle of inclination α
65.00	39.00	18.00	10	6° 02'
80.00	54.00	33.00	10	4° 47'
100.00	74.00	53.00	10	3° 44'
120.00	94.00	73.00	10	3° 04'
132.00	106.00	85.00	10	2° 46'

Forming tool profile



Our engineers are routinely meeting the demands of complex design problems. Having the specific tools needed for your metal forming project can mean the difference between success and failure. Contact us with your unique application for custom tooling.

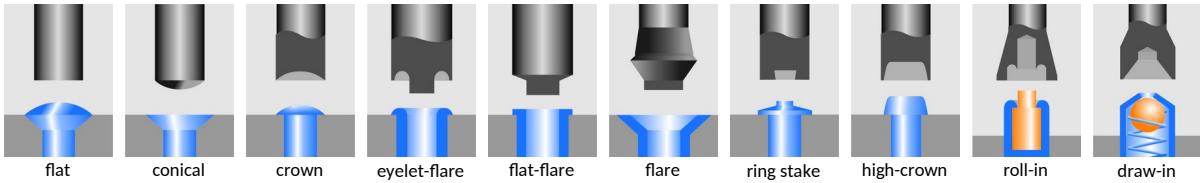

Industries & Applications



BalTec AG
Switzerland / Germany

BalTec (UK) Ltd.
United Kingdom

BalTec France
France

BalTec Corporation
USA / Canada / Mexico

BalTec do Brasil
Brazil

BalTec Machinery (Shanghai) Ltd.
China

BalTec Italia Srl
Italia

BalTec